



# INSTRUMEX SURGICAL INSTRUMENTS



*Plastic Surgery*  
**Instruments Catalogue**  
[www.instrumexsurgical.com](http://www.instrumexsurgical.com)

## INSTRUMEX SURGICAL INSTRUMENTS

### ABOUT US

**INSTRUMEX SURGICAL** is a leading global provider of innovative surgical solutions, dedicated to empowering surgeons and healthcare professionals to deliver high-quality patient care. With a strong focus on research and development, we design, manufacture, and distribute a comprehensive range of surgical instruments and solutions for invasive surgery.

Our commitment to excellence, quality, and customer satisfaction has made us a trusted partner for hospitals, clinics, and medical professionals worldwide. Our state-of-the-art facilities, advanced manufacturing technologies, and skilled team of experts enable us to drive innovation and stay at the forefront of the industry.

At **INSTRUMEX SURGICAL INSTRUMENTS** we are passionate about improving patient outcomes and advancing the field of surgery. Our goal is to make a positive impact on people's lives through our products, services, and partnerships.”





## Scissors



- Gorney**
- IS-08-21518 18.0 cm, curved, serrated, TC
  - IS-08-21420 20.0 cm, straight, serrated, TC
  - IS-08-21520 20.0 cm, curved, serrated, TC
  - IS-08-21523 23.0 cm, curved, serrated, TC



- Gorney**
- IS-08-21220 20.0 cm, straight, serrated
  - IS-08-21320 20.0 cm, curved, serrated



- Freeman Gorney**
- IS-08-21620 20.0 cm, straight, TC
  - IS-08-21720 20.0 cm, curved, TC



- Freeman**
- IS-08-21918 18.0 cm, straight, TC
  - IS-08-22018 18.0 cm, curved, TC





## Scissors

**Aston-Face**  
IS-08-24516 17.0 cm, curved  
IS-08-24520 20.0 cm, curved



**Rees**  
IS-08-22417 17.0 cm, straight, serrated, TC  
IS-08-22517 17.0 cm, curved, serrated, TC  
IS-08-22419 20.0 cm, straight, serrated, TC  
IS-08-22519 20.0 cm, curved, serrated, TC



**Kaye**  
IS-08-23315 15.0 cm, curved, serrated, TC  
IS-08-23323 23.0 cm, curved, serrated, TC



**Kaye**  
IS-08-23312 11.5 cm, curved, serrated, TC





## Scissors



### Freeman (Kaye)

- IS-08-21818 18.0 cm, curved, serrated, TC
- IS-08-21820 20.0 cm, curved, serrated, TC



### Davis

- IS-08-24018 18.0 cm, curved, serrated, sharp/sharp, TC



### Castanares

- IS-08-24816 16.5 cm, straight, TC



### Goldman Fox

- D 08-82313 13.0 cm, curved, serrated, TC





## Scissors

### Par Style

very delicate

**IS-08-20911**

11.5 cm, curved, TC

**IS-08-20914**

14.5 cm, curved, TC

for serrated blades please add "WS"

### Stevens Tenotomy

**IS-08-36051**

11.5 cm, straight, TC

**IS-08-36151**

11.5 cm, curved, TC

### Stevens Tenotomy

**IS-08-36011**

11.0 cm, straight, sharp/sharp

**IS-08-36111**

11.0 cm, curved, sharp/sharp

**IS-08-36211**

11.0 cm, straight, blunt/blunt

**IS-08-36311**

11.0 cm, curved, blunt/blunt

### Devine

fine dissecting scissors  
with sharp tips,

**IS-08-21011**

11.0 cm, curved, TC





## Scissors



- Kilner**
- D 108-31212** 12.0 cm, straight, TC
  - D 108-31412** 12.0 cm, curved, TC
  - D 5851BLHM** 12.0 cm, curved  
1 blade TC  
1 blade serrated



- Strabismus**
- IS-08-37411** 11.0 cm, straight, TC
  - IS-08-37511** 11.0 cm, curved, TC
  - IS-07-37411** 11.0 cm, straight, supercut
  - IS-07-37511** 11.0 cm, curved, supercut
- for serrated blades please add "WS"



- Iris**
- IS-08-34211** 11.5 cm, round, straight, sharp/sharp
  - IS-08-34311** 11.5 cm, round, curved, sharp/sharp
  - IS-08-34251** 11.5 cm, round, straight, sharp/sharp, TC
  - IS-08-34351** 11.5 cm, round, curved, sharp/sharp, TC
- for serrated blades please add "WS"



- Iris**
- IS-08-34011** 11.5 cm, square, straight, sharp/sharp
  - IS-08-34111** 11.5 cm, square, curved, sharp/sharp
  - IS-08-34411** 11.5 cm, square, straight, sharp/sharp, TC
  - IS-08-34511** 11.5 cm, square, curved, sharp/sharp, TC
- for serrated blades please add "WS"





## Scissors

### Joseph

- IS-08-30414 14.0 cm, straight, sharp/sharp
- IS-08-30514 14.0 cm, curved, sharp/sharp
- IS-08-30454 14.0 cm, straight, sharp/sharp, TC
- IS-08-30554 14.0 cm, curved, sharp/sharp, TC



### Locklin

- IS-08-53916 16.0 cm, straight, angled, sharp/sharp, TC



### Shea

- IS-08-30612 12.0 cm, sharp, fine, curved





## Scissors



**Heymann**  
IS-08-40118 18.0 cm, angled to side



**Knight**  
IS-08-39518 18.0 cm, angled to side, serrated,  
delicate blades, TC



**Wilmer Converse**  
IS-08-35010 10.5 cm, angled up





## Scissors

**IS-08-40213**  
**Fomon**  
13.5 cm, lower lateral scissor,  
strongly curved



**IS-08-40354**  
**Fomon**  
14.5 cm, angled, TC



**IS-08-40716**  
**Cottle**  
17.0 cm, angled, TC





## Scissors



**IS-46-26120**

### Caplan Septum

22.0 cm, one blade serrated,  
double action, straight

**IS-46-26122**

22.0 cm, one blade serrated,  
double action, curved



**IS-08-28415**

### Metzenbaum blunt/blunt

14.5 cm, straight, TC

**IS-08-28515**

14.5 cm, curved, TC

**IS-08-28418**

18.0 cm, straight, TC

**IS-08-28518**

18.0 cm, curved, TC

**IS-08-28420**

20.5 cm, straight, TC

**IS-08-28520**

20.5 cm, curved, TC

**IS-08-28423**

23.0 cm, straight, TC

**IS-08-28523**

23.0 cm, curved, TC

**IS-08-28428**

28.0 cm, straight, TC

**IS-08-28528**

28.0 cm, curved, TC

for serrated blades please add "WS"



**IS-07-28015**

### Metzenbaum, blunt/blunt

14.5 cm, straight, supercut

**IS-07-28115**

14.5 cm, curved, supercut

**IS-07-28018**

18.0 cm, straight, supercut

**IS-07-28118**

18.0 cm, curved, supercut

**IS-07-28023**

23.0 cm, straight, supercut

**IS-07-28123**

23.0 cm, curved, supercut





## Scissors

### Metzenbaum Fino blunt/blunt

- IS-08-28615** 14.5 cm, straight, TC
- IS-08-28715** 14.5 cm, curved, TC
- IS-08-28618** 18.0 cm, straight, TC
- IS-08-28718** 18.0 cm, curved, TC
- IS-08-28620** 20.0 cm, straight, TC
- IS-08-28720** 20.0 cm, curved, TC
- IS-08-28623** 23.0 cm, straight, TC
- IS-08-28723** 23.0 cm, curved, TC
- IS-08-28628** 28.0 cm, straight, TC
- IS-08-28728** 28.0 cm, curved, TC

for serrated blades please add "WS"



### Metzenbaum sharp/sharp

- IS-08-27415** 14.5 cm, straight, TC
- IS-08-27515** 14.5 cm, curved, TC
- IS-08-27418** 18.0 cm, straight, TC
- IS-08-27518** 18.0 cm, curved, TC
- IS-08-27423** 23.0 cm, straight, TC
- IS-08-27523** 23.0 cm, curved, TC

for serrated blades please add "WS"



### Mayo-Stille

- IS-08-17415** 15.0 cm, straight, TC
- IS-08-17515** 15.0 cm, curved, TC
- IS-08-17417** 17.0 cm, straight, TC
- IS-08-17517** 17.0 cm, curved, TC

for serrated blades please add "WS"





## Scissors



**IS-07-17017**  
**IS-07-17117**

### Mayo-Stille

17.0 cm, straight, supercut  
17.0 cm, curved, supercut



**IS-08-19421**  
**IS-08-19521**

### Mayo-Lexer

21.0 cm, straight, TC  
21.0 cm, curved, TC



**IS-08-11214**  
**IS-08-11314**

### Operating sharp/blunt

14.5 cm, straight, round, TC  
14.5 cm, curved, round, TC





## Scissors

**IS-08-12214**    **Operating sharp/sharp**  
14.5 cm, straight, round, TC  
**IS-08-12314**    14.5 cm, curved, round, TC



**IS-08-10614**    **Operating blunt/blunt**  
14.5 cm, straight, round, TC  
**IS-08-10714**    14.5 cm, curved, round, TC



**IS-08-83512**    **Universal Wire Scissors**  
12.0 cm, serrated, TC

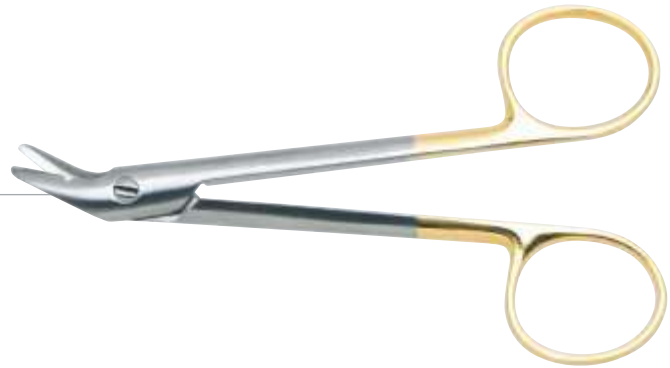

**IS-08-36509**    **Stevens Tenotomy Scissors**  
9.5 cm, curved, sharp/sharp, ribbon type  
**IS-08-36512**    12.0 cm, curved, sharp/sharp, ribbon type





## Scissors



### Iris

- IS-08-32209** 9.5 cm, straight, sharp/sharp, ribbon type
- IS-08-32309** 9.5 cm, curved, sharp/sharp, ribbon type
- IS-08-32610** 10.5 cm, straight, sharp/sharp, ribbon type
- IS-08-32710** 10.5 cm, curved, sharp/sharp, ribbon type



### Littler

- IS-08-20512** 12.0 cm, curved, tips with eye for suture
- IS-08-20514** 14.0 cm, curved, tips with eye for suture



### Spencer

- IS-08-80209** 9.0 cm, straight, ligature scissor



### Knowles Bandage

- IS-08-93114** 14.0 cm, angled, serrated





## Scissors

### Lister Bandage

IS-08-90114

14.0 cm, angled

IS-08-90118

18.0 cm, angled



### Freeman Kaye

IS-08-21617

17.0 cm, curved



### Micro Scissors

spring scissors with round handle, blade 14 mm

IS-09-20615

15.0 cm, straight

IS-09-20815

15.0 cm, straight, blades serrated

IS-09-20715

15.0 cm, curved

IS-09-20915

15.0 cm, curved, blades serrated

IS-09-20618

18.0 cm, straight

IS-09-20818

18.0 cm, straight, blades serrated

IS-09-20718

18.0 cm, curved

IS-09-20918

18.0 cm, curved, blades serrated





## Needle Holders



**IS-24-12811**  
**IS-24-12913**

### Webster

11.5 cm, smooth  
13.0 cm, smooth, TC

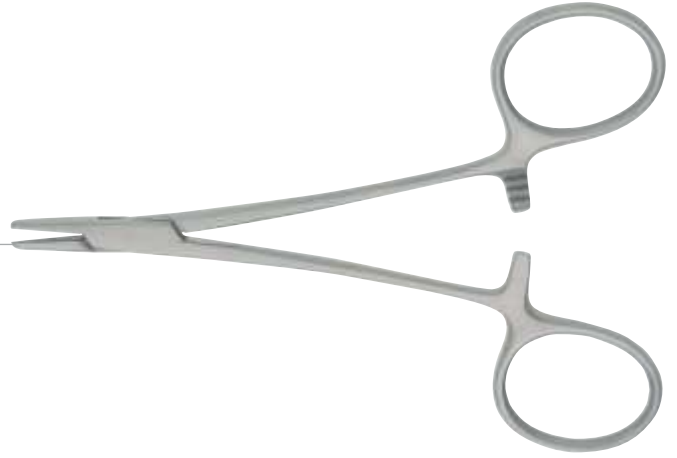

**IS-24-13413**  
**IS-24-14413**

### Halsey

13.0 cm, smooth, TC  
13.0 cm, cross serrated, TC



**IS-24-14011**  
**IS-24-14013**

### Par

11.5 cm, cross serrated, TC  
13.0 cm, cross serrated, TC





## Needle Holders

**Derf**  
IS-24-11012 12.0 cm, serrated  
IS-24-11412 12.0 cm, cross serrated, TC



**Neivert**  
IS-24-14713 13.0 cm, cross serrated, TC



**Swedish**  
IS-24-21815 15.5 cm, cross serrated, TC

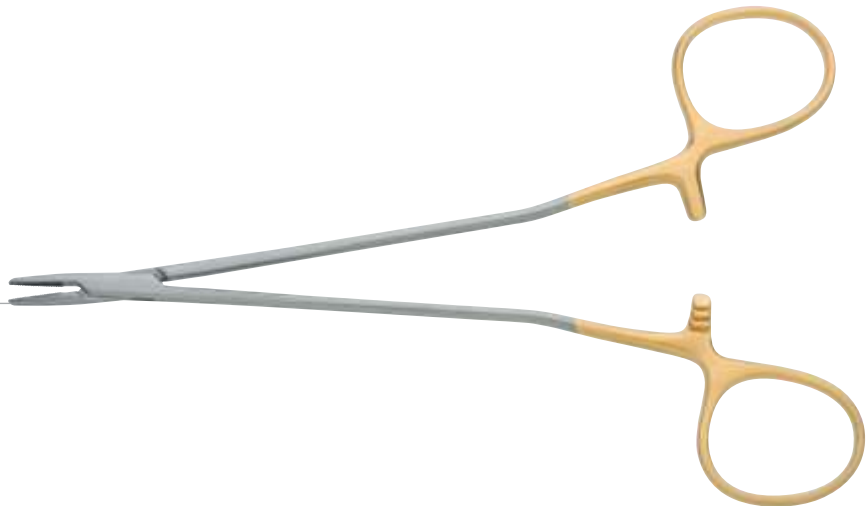



## Needle Holders



### Ryder

- IS-24-22413 13.0 cm, cross serrated, TC
- IS-24-22415 15.0 cm, cross serrated, TC
- IS-24-22418 18.0 cm, cross serrated, TC



### Micro Ryder

- IS-24-22613 13.0 cm, cross serrated, TC
- IS-24-22615 15.0 cm, cross serrated, TC
- IS-24-22618 18.0 cm, cross serrated, TC

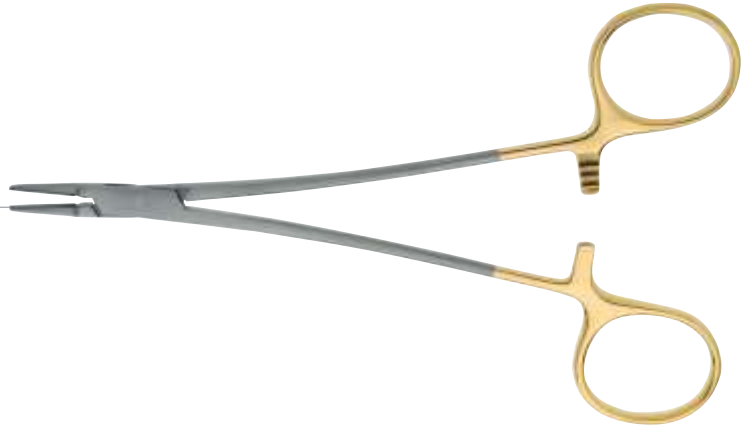

### Euphrate-Pasque

extremely delicate

- IS-24-23814 14.0 cm, cross serrated, TC
- IS-24-23815 15.0 cm, cross serrated, TC
- IS-24-23818 18.0 cm, cross serrated, TC
- IS-24-23820 20.0 cm, cross serrated, TC

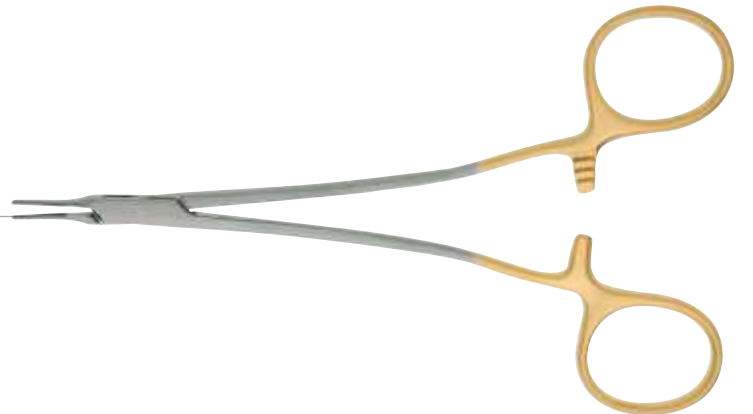



## Needle Holders

### Micro-Vascular

- IS-24-23415 15.0 cm, cross serrated, TC
- IS-24-23418 18.0 cm, cross serrated, TC

### Crile-Wood

- IS-24-16215 15.0 cm, smooth, TC
- IS-24-16415 15.0 cm, cross serrated, TC
- IS-24-16418 18.0 cm, cross serrated, TC
- IS-24-16420 20.0 cm, cross serrated, TC
- IS-24-16423 23.0 cm, cross serrated, TC

### Lemmon

- IS-24-24814 14.0 cm, cross serrated, TC
- IS-24-24817 17.0 cm, cross serrated, TC
- IS-24-24819 19.0 cm, cross serrated, TC

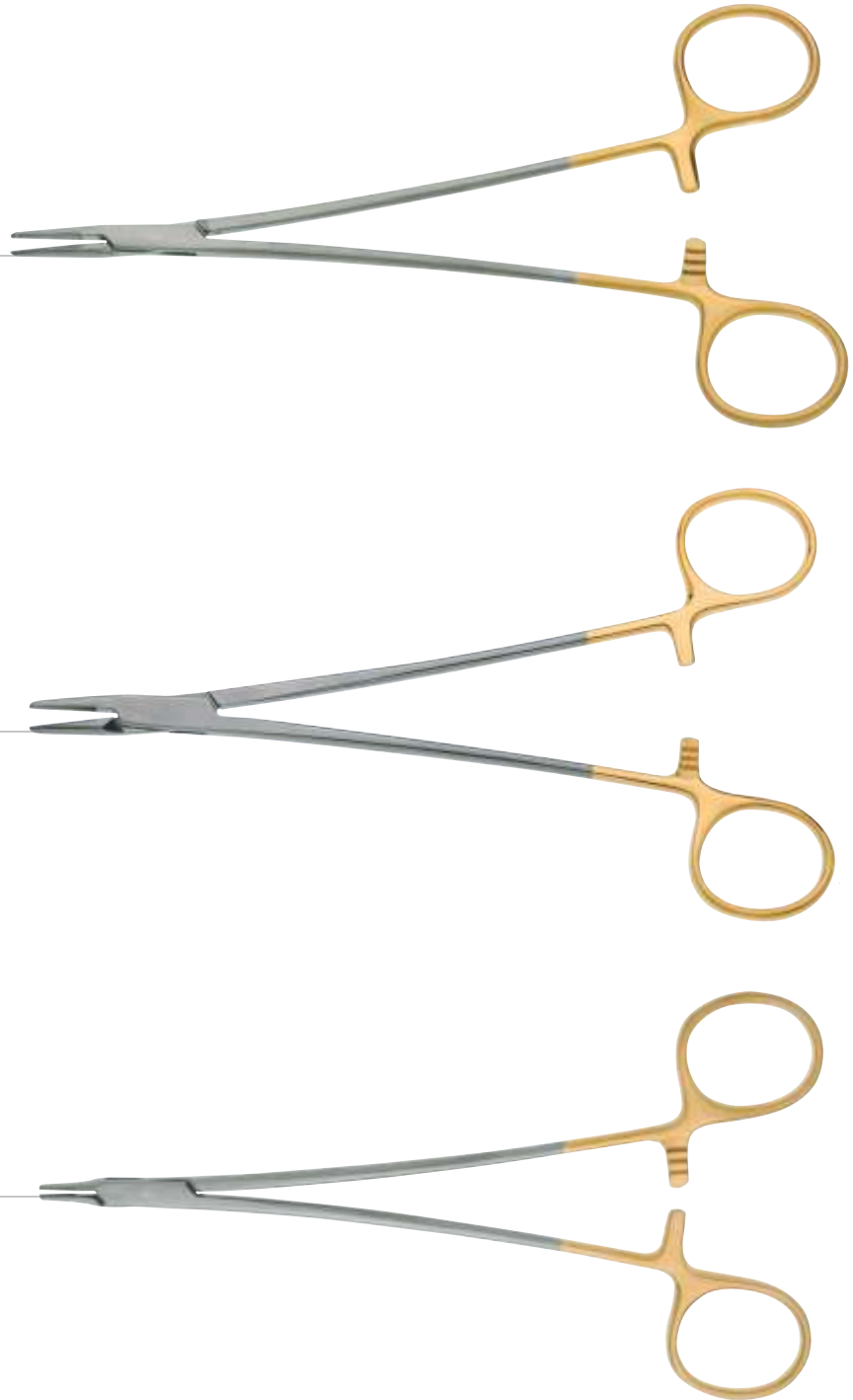



## Needle Holders



### Baumgartner

- IS-24-15412** 12.5 cm, cross serrated, TC
- IS-24-15414** 14.0 cm, cross serrated, TC



### Mayo Hegar

- IS-24-18414** 14.0 cm, cross serrated, TC
- IS-24-18416** 16.0 cm, cross serrated, TC
- IS-24-18418** 18.0 cm, cross serrated, TC
- IS-24-18420** 20.0 cm, cross serrated, TC



### Wire Twister

- IS-33-60011** 13.0 cm, round jaw, cross serrated, TC
- IS-33-60001** 16.0 cm, blunt jaw, cross serrated, TC
- IS-33-60012** 18.0 cm, round jaw, cross serrated, TC
- IS-33-60002** 18.0 cm, blunt jaw, cross serrated, TC

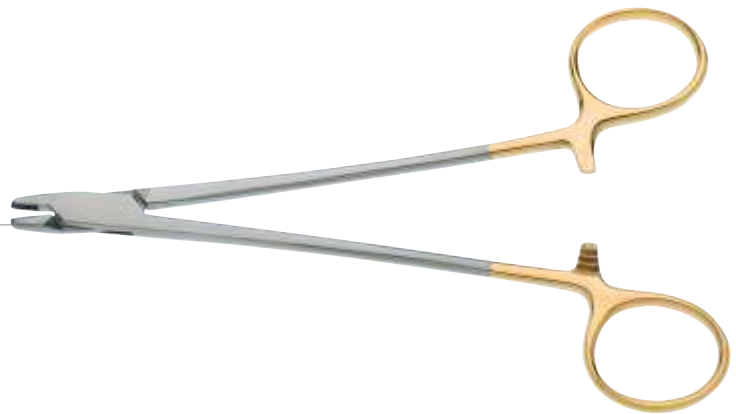



## Needle Holders

### Corwin Wire Twister

- IS-33-53901 16.0 cm, long round jaw, cross serrated, TC
- IS-33-53902 16.0 cm, blunt jaw, cross serrated, TC
- IS-33-53903 16.0 cm, round jaw, cross serrated, TC



### Olsen Hegar

needleholder/scissors combination

- IS-24-41414 14.0 cm, cross serrated, TC
- IS-24-41418 18.0 cm, cross serrated, TC



### Gillies

needleholder/scissors combination

- IS-24-43416 16.0 cm, cross serrated, curved, TC





## Needle Holders



- Barraquer Micro**  
with round handle, without lock, tip 0.8 × 1.2 mm
- IS-24-64014** 14.0 cm, straight, diamond dusted
  - IS-24-64114** 14.0 cm, curved, diamond dusted
  - IS-24-64015** 15.0 cm, straight, diamond dusted
  - IS-24-64115** 15.0 cm, curved, diamond dusted
  - IS-24-64018** 18.0 cm, straight, diamond dusted
  - IS-24-64118** 18.0 cm, curved, diamond dusted



- Barraquer Micro**  
with round handle, with lock, tip 0.8 × 1.2 mm
- IS-24-64214** 14.0 cm, straight, diamond dusted
  - IS-24-64314** 14.0 cm, curved, diamond dusted
  - IS-24-64215** 15.0 cm, straight, diamond dusted
  - IS-24-64315** 15.0 cm, curved, diamond dusted
  - IS-24-64218** 18.0 cm, straight, diamond dusted
  - IS-24-64318** 18.0 cm, curved, diamond dusted

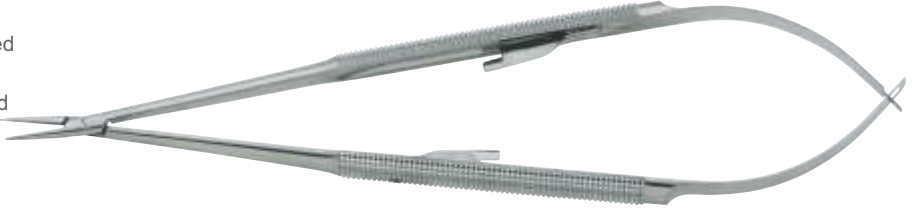



## Needle Holders

### Barraquer Delicate

with round handle, without lock, tip 1.2 × 1.8 mm

- IS-24-63414** 14.0 cm,  
cross serrated, straight, TC
- IS-24-63514** 14.0 cm,  
cross serrated, curved, TC
- IS-24-63415** 15.0 cm,  
cross serrated, straight, TC
- IS-24-63515** 15.0 cm,  
cross serrated, curved, TC
- IS-24-63418** 18.0 cm,  
cross serrated, straight, TC
- IS-24-63518** 18.0 cm,  
cross serrated, curved, TC



### Barraquer Micro

with round handle, without lock, tip 0.8 × 1.2 mm

- IS-24-63614** 14.0 cm,  
cross serrated, straight, TC
- IS-24-63714** 14.0 cm,  
cross serrated, curved, TC
- IS-24-63615** 15.0 cm,  
cross serrated, straight, TC
- IS-24-63715** 15.0 cm,  
cross serrated, curved, TC
- IS-24-63618** 18.0 cm,  
cross serrated, straight, TC
- IS-24-63718** 18.0 cm,  
cross serrated, curved, TC





## Needle Holders



- Barraquer Delicate**  
with round handle, with lock, tip 1.2 × 1.8 mm
- IS-24-66714** 14.0 cm, cross serrated, straight, TC
  - IS-24-66614** 14.0 cm, cross serrated, curved, TC
  - IS-24-66715** 15.0 cm, cross serrated, straight, TC
  - IS-24-66615** 15.0 cm, cross serrated, curved, TC
  - IS-24-66718** 18.0 cm, cross serrated, straight, TC
  - IS-24-66618** 18.0 cm, cross serrated, curved, TC



- Barraquer Micro**  
with round handle, with lock, tip 0.8 × 1.2 mm
- IS-24-66814** 14.0 cm, cross serrated, straight, TC
  - IS-24-66914** 14.0 cm, cross serrated, curved, TC
  - IS-24-66815** 15.0 cm, cross serrated, straight, TC
  - IS-24-66915** 15.0 cm, cross serrated, curved, TC
  - IS-24-66818** 18.0 cm, cross serrated, straight, TC
  - IS-24-66918** 18.0 cm, cross serrated, curved, TC



- Castroviejo**  
with fat handle, with lock
- IS-24-67813** 14.0 cm, smooth, straight, TC
  - IS-24-67814** 14.0 cm, cross serrated, straight, TC
  - IS-24-67513** 14.0 cm, smooth, curved, TC
  - IS-24-67514** 14.0 cm, cross serrated, curved, TC
  - IS-24-67817** 18.0 cm, smooth, straight, TC
  - IS-24-67819** 18.0 cm, cross serrated, straight, TC
  - IS-24-67517** 18.0 cm, smooth, curved, TC
  - IS-24-67518** 18.0 cm, cross serrated, curved, TC





## Needle Holders

### Castroviejo

with fat handle, without lock

**IS-24-69614**

14.0 cm, straight, diamond dusted

**IS-24-69714**

14.0 cm, curved, diamond dusted

**IS-24-69618**

18.0 cm, straight, diamond dusted

**IS-24-69718**

18.0 cm, curved, diamond dusted



### Castroviejo

with fat handle, with lock

**IS-24-69814**

14.0 cm,  
straight, diamond dusted

**IS-24-69914**

14.0 cm,  
curved, diamond dusted

**IS-24-69818**

18.0 cm,  
straight, diamond dusted

**IS-24-69918**

18.0 cm,  
curved, diamond dusted



### Castroviejo Ryder

with fat handle, with lock

**IS-24-70214**

14.0 cm, cross serrated,  
straight, TC

**IS-24-70218**

18.0 cm, cross serrated,  
straight, TC



### Barraquer

with round handle, with inserted jaws 0.75mm

**IS-24-65712**

12.0 cm, straight, without lock, smooth

**IS-24-65912**

12.0 cm, curved, without lock, smooth





## Forceps / Thumb



- |                    |  |  |
|--------------------|--|--|
| <b>IS-10-17412</b> | <b>Adson</b><br>12.0 cm, cross serrated, TC            |    |
| <b>IS-10-17415</b> | 15.0 cm, cross serrated, TC                            |  |
| <b>IS-10-20412</b> | <b>Adson</b><br>12.0 cm, serrated, Titanium            |    |
| <b>IS-10-17012</b> | <b>Adson</b><br>12.0 cm, serrated                      |    |
| <b>IS-10-17612</b> | 12.0 cm, serrated, Micro                               |  |
| <b>IS-10-17912</b> | <b>Adson Dressing</b><br>12.0 cm, cross serrated       |  |
| <b>IS-10-17512</b> | <b>Adson</b><br>12.0 cm, cross serrated, 1x2 teeth, TC |  |
| <b>IS-10-17515</b> | 15.0 cm, cross serrated, 1x2 teeth, TC                 |  |
| <b>IS-10-20512</b> | <b>Adson</b><br>12.0 cm, smooth, 1x2 teeth, Titanium   |  |
| <b>IS-10-18012</b> | <b>Adson Tissue</b><br>12.0 cm, smooth, 1x2 teeth      |  |



## Forceps / Thumb

<b>IS-10-18512</b>	<b>Adson Tubiana</b> 12.0 cm, 1x2 teeth, with platform 1 mm	
<b>IS-10-18802</b> <b>IS-10-18805</b>	<b>Brown-Adson</b> 12.0 cm, cross serrated, Brown teeth, TC 15.0 cm, cross serrated, Brown teeth, TC	
<b>IS-10-18812</b>	<b>Brown-Adson</b> 12.0 cm, Brown teeth	
<b>IS-10-17312</b> <b>IS-10-17315</b>	<b>Adson Micro</b> 12.0 cm, cross serrated, 1x2 teeth, TC 15.0 cm, cross serrated, 1x2 teeth, TC	
<b>IS-10-17452</b>	<b>Par</b> 12.0 cm, cross serrated, TC	
<b>IS-10-16912</b> <b>IS-10-17455</b>	<b>Adson Delicate</b> 12.0 cm, smooth, TC 15.0 cm, cross serrated, TC	
<b>IS-10-18612D</b>	<b>Gorney-Adson</b> 12.0 cm, 1x2 teeth, with platform, diamond dusted	





## Forceps / Thumb



- Castroviejo**
- IS-43-14915** 10,5 cm, 1.5 mm tip, 1x2 teeth, with platform
  - IS-43-14903** 10,5 cm, 3 mm tip, 1x2 teeth, with platform
  - IS-43-14905** 10,5 cm, 5 mm tip, 1x2 teeth, with platform
  - IS-43-14909** 10,5 cm, 9 mm tip, 1x2 teeth, with platform



- Castroviejo-Brown**
- IS-10-18851** 11.0 cm, brown teeth



- Graefe Iris**
- IS-42-82010** 10.0 cm, smooth, 1x2 teeth



- Graefe Iris**
- IS-42-81010** 10.0 cm, serrated



- Julian Suture**
- IS-42-82511** 11.0 cm, smooth, curved



- Adson-Graefe**
- IS-10-20012** 12.0 cm, multi-toothed





## Forceps / Thumb

### Bishop-Harmon

- IS-42-94004 8.5 cm, smooth, 1x2 teeth, fine
- IS-42-94006 8.5 cm, smooth, 1x2 teeth



### Green Fixation

- IS-43-07605 10.0 cm, 5 mm tip, without lock
- IS-43-07610 10.0 cm, 10 mm tip, without lock
- IS-43-07612 10.0 cm, 12 mm tip, without lock
- IS-43-07805 10.0 cm, 5 mm tip, with lock
- IS-43-07810 10.0 cm, 10 mm tip, with lock
- IS-43-07812 10.0 cm, 12 mm tip, with lock



### Semken

- IS-10-26915 15.0 cm, cross-serrated, 1x2 teeth, TC



### McIndoe Dissecting

- IS-10-25815 15.0 cm, serrated



### Gillies Dissecting

- IS-10-27215 15.0 cm, cross serrated, 1x2 teeth



### General

- IS-10-11115 15.0 cm, cross serrated, TC





## Forceps / Thumb



**IS-10-22417** **Cushing**  
17.0 cm, cross serrated, TC



**IS-10-22217** **Cushing**  
17.0 cm, serrated, Titanium



**IS-10-22517** **Cushing**  
17.0 cm, angled, cross serrated, TC



**IS-10-22618** **Taylor Cushing**  
18.5 cm, cross serrated, bayonet, TC



**IS-10-25317** **Bonney**  
17.5 cm, cross serrated, 1x2 teeth, TC



**IS-10-11618** **Potts-Smith**  
18.0 cm, cross serrated, TC  
**IS-10-11621** 21.0 cm, cross serrated, TC  
**IS-10-11625** 25.0 cm, cross serrated, TC





## Forceps / Thumb

### Gerald

- IS-10-30618** 18.0 cm, cross serrated, 1x2 teeth, TC
- IS-10-30118** 18.0 cm, cross serrated, TC



### Skinner

- IS-10-32323** 23.0 cm, cross serrated, 1x2 teeth, TC



### DeBakey Titanium

- IS-11-30015** 15.0 cm, 1.5 mm tip, Titanium
- IS-11-30020** 19.5 cm, 1.5 mm tip, Titanium
- IS-11-30024** 24.0 cm, 1.5 mm tip, Titanium
- IS-11-30315** 15.0 cm, 2.3 mm tip, Titanium
- IS-11-30320** 19.5 cm, 2.3 mm tip, Titanium
- IS-11-30324** 24.0 cm, 2.3 mm tip, Titanium



### DeBakey

- IS-11-30616** 16.0 cm, 1.5 mm jaw
- IS-11-30620** 20.0 cm, 1.5 mm jaw
- IS-11-30624** 24.0 cm, 1.5 mm jaw
- IS-11-30816** 16.0 cm, 2.0 mm jaw
- IS-11-30820** 20.0 cm, 2.0 mm jaw
- IS-11-30824** 24.0 cm, 2.0 mm jaw
- IS-11-30830** 30.0 cm, 2.0 mm jaw
- IS-11-30416** 16.0 cm, 2.7 mm jaw
- IS-11-30420** 20.0 cm, 2.7 mm jaw
- IS-11-30424** 24.0 cm, 2.7 mm jaw
- IS-11-30430** 30.0 cm, 2.7 mm jaw
- IS-11-31016** 16.0 cm, 3.5 mm jaw
- IS-11-31020** 20.0 cm, 3.5 mm jaw
- IS-11-31024** 24.0 cm, 3.5 mm jaw
- IS-11-31030** 30.0 cm, 3.5 mm jaw





## Forceps / Thumb



**IS-44-20616**      **Lucae-Jansen**  
16.0 cm, serrated



**IS-46-15420**      **Jansen Gruenwald**  
20.0 cm, serrated



**IS-44-20614**      **Lucae**  
14.0 cm, serrated





## Forceps / Thumb

### Jewelers diamond dusted

IS-10-33525		11.5 cm, # 5A, very fine pointed tips
IS-10-33503		11.5 cm, # 3, straight, delicate tips
IS-10-33504		11.5 cm, # 4, straight, very fine tips
IS-10-33505		11.0 cm, # 5, straight, ultra fine tips
IS-10-33515		11.0 cm, # 5/45, angled, ultra fine tips
IS-10-33507		11.5 cm, # 7, curved, delicate tips



### Jewelers

IS-10-33201		11.5 cm, # 1, straight, standard tips
IS-10-33012		11.5 cm, # 3, straight, delicate tips
IS-10-33225		11.0 cm, # 5A, very fine pointed tips
IS-10-33010		10.5 cm, # 3C, straight, delicate tips
IS-10-33204		11.0 cm, # 4, straight, very fine tips
IS-10-33205		11.0 cm, # 5, straight, ultra fine tips
IS-10-33100		11.0 cm, # 5/45, angled, ultra fine tips
IS-10-33112		11.0 cm, # 7, curved, delicate tips



### Micro-Forceps

round handle, with tying platform

IS-11-10415	15.0 cm, straight, smooth
IS-11-10818	18.0 cm, straight, smooth
IS-11-10515	15.0 cm, curved, smooth
IS-11-10918	18.0 cm, curved, smooth



## Nasal Rasps



### Fomon

- IS-46-52201** 20.0 cm, #1 and #2, TC
- IS-46-52203** 20.0 cm, #3 and #4, TC
- IS-46-52205** 20.0 cm, #5 and #6, TC
- IS-46-52207** 20.0 cm, #7 and #8, TC



### Glabella

- IS-46-50501** 21.5 cm, TC



### Peet

- IS-46-50919** 19.0 cm, straight
- IS-46-50920** 19.0 cm, curved



### Miller Colburn File

- IS-82-89501** 18.0 cm, #1
- IS-82-89502** 18.0 cm, #2
- IS-82-89503** 18.0 cm, #3
- IS-82-89504** 18.0 cm, #4
- IS-82-89505** 18.0 cm, #5



### McIndoe

- IS-46-53018** 17.5 cm, forward cutting, straight





## Nasal Rasps

- IS-46-51916** **Maltz**  
16.5 cm,  
backward cutting,  
straight
- IS-46-53101** **Lamont**  
17.5 cm,  
backward cutting, wide,  
straight, aggressive teeth
- IS-46-53102** **Lamont**  
17.5 cm,  
backward cutting, delicate,  
straight, fine teeth
- IS-46-53103** **Lamont**  
17.5 cm,  
backward cutting, straight,  
fine teeth
- IS-46-50604** **Parkes**  
21.0 cm, # 4, backward cutting,  
straight, TC
- IS-46-50605** **Parkes**  
21.0 cm, # 5, backward cutting,  
straight, TC
- IS-46-50608** **Parkes**  
21.0 cm, # 8, backward cutting,  
straight, TC
- 



## Nasal Rasps



**IS-46-51022** **Peet Aufricht**  
21.0 cm,  
fne curved,  
diamond dusted



**IS-46-52401** **Fomon**  
21.5 cm, fne



**IS-46-52402** **Fomon**  
21.5 cm, coarse



**IS-46-52321** **Fomon**  
21.0 cm,  
diamond dusted





## Nasal Rasps





## Retractors

### Ferreira retractor

**IS-48-56411** 11.0 cm x 2.2 cm, face lift retractor with fiberoptic



### Flap retractor

**IS-18-56112** 11.0 cm, 2.2 cm blade



### Tebbetts Style

T-Mammoplasty retractor with smoke evacuation tube and fiberoptic illumination, with Storz, HSW, ACMI adapter included

- IS-18-55080** 16 x 80 mm blade, without teeth
- IS-18-55090** 24 x 90 mm blade, without teeth
- IS-18-55092** 30 x 90 mm blade, without teeth
- IS-18-55100** 24 x 100 mm blade, without teeth
- IS-18-55120** 25 x 120 mm blade, without teeth
- IS-18-55122** 30 x 120 mm blade, without teeth
- IS-18-55150** 25 x 150 mm blade, without teeth
- IS-18-55152** 30 x 150 mm blade, without teeth
- IS-18-55154** 36 x 150 mm blade, without teeth
- IS-18-55170** 40 x 170 mm blade, without teeth
- IS-18-55190** 30 x 190 mm blade, without teeth
- IS-18-55480** 16 x 80 mm blade, with teeth
- IS-18-55490** 24 x 90 mm blade, with teeth
- IS-18-55492** 30 x 90 mm blade, with teeth
- IS-18-55500** 24 x 100 mm blade, with teeth
- IS-18-55520** 25 x 120 mm blade, with teeth
- IS-18-55522** 30 x 120 mm blade, with teeth
- IS-18-55550** 25 x 150 mm blade, with teeth
- IS-18-55552** 30 x 150 mm blade, with teeth
- IS-18-55554** 36 x 150 mm blade, with teeth
- IS-18-55570** 40 x 170 mm blade, with teeth
- IS-18-55590** 30 x 190 mm blade, with teeth





## Retractors

**IS-18-17925** **Deaver**  
20.0 cm, retractor with fiberoptic



**IS-18-19612** **Freeman Flap**  
20.5 cm, retractor, 12 mm blade width  
**IS-18-19625** retractor, 25 mm blade width



**IS-18-56019** **Multiple approach retractor**  
19.0 cm, 23 mm blade





## Retractors



**IS-18-57001**

### Biggs Mammoplasty Retractor

standard blade, 50 mm

**IS-18-57011**

standard blade with fiber-optics, 50 mm

**IS-18-57021**

standard blade with fiber-optics and suction tube, 50 mm

**IS-18-57002**

narrow blade, 31 mm

**IS-18-57012**

narrow blade with fiber-optics, 31 mm

**IS-18-57022**

narrow blade with fiber-optics and suction tube, 31 mm

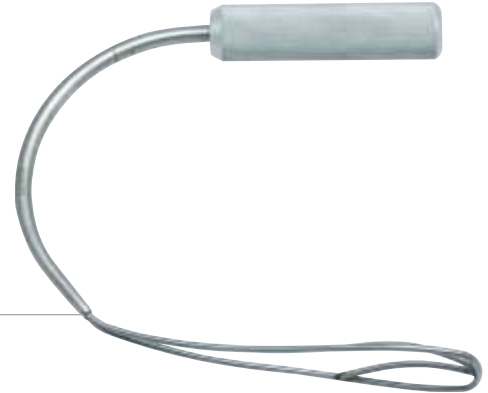

**IS-46-54105**

### Converse

11.0 cm, nasal retractor,  
11x44 mm blade

**IS-46-54125**

11.0 cm, nasal retractor,  
11x44 mm blade, with fiber optics



**IS-46-55116**

### Aufricht

16.0 cm, nasal retractor,  
45 mm blade

**IS-46-55126**

16.0 cm, nasal retractor,  
45 mm blade, with fiber optics



**IS-46-55920**

### Cottle

20.0 cm, retractor  
with knife guard





## Retractors

- IS-18-65010** **Weitlaner**  
11.5 cm, retractor,  
2x3 sharp prongs
- IS-18-67014**  
14.0 cm, retractor,  
3x4 sharp prongs



- IS-46-55508** **Swivel double hook**  
8.0 cm, sharp, 10 mm



- IS-46-54516** **Sheen**  
16.0 cm, nasal retractor



- IS-18-17731** **Spatula, semi-malleable**  
31.5 cm, 2.5x15.5 cm blade





## Retractors



**IS-18-19516** **Hamra**  
16.0 cm, double ended retractor



**IS-46-55614** **Cottle**  
14.0 cm, retractor, double hook, sharp



**IS-46-55616** **Fomon**  
16.0 cm, alar retractor,  
double hook with ball ends



**IS-46-55412** **Converse Alar**  
10.0 cm, retractor double ended,  
10mm / 14mm, blunt



**IS-46-55511** **Martinez Kilner**  
11.5 cm, retractor double hook  
with thimble, 10mm wide, sharp





## Retractors

### U.S. Army

21.0 cm, retractor,  
double ended, pair

IS-18-13121



### Maxwell Flap

10.0 cm x 22 mm, four prongs retractor  
10.0 cm x 38 mm, four prongs retractor

IS-18-25122

IS-18-25138



### Freeman Rake

18.0 cm x 22 mm,  
four prongs retractor

IS-18-25222

18.0 cm x 38 mm,  
four prongs retractor

IS-18-25238



### Anderson Bear Claw

11.0 cm, 3 prongs, sharp

IS-18-24911

11.0 cm, 5 prongs, sharp

IS-18-25011





## Retractors



**Freeman**  
IS-46-56502 10.0 cm, double skin hook, sharp



**Yancoskie lift retractor**  
IS-18-25615 15.0 cm, 6 prongs



**Lift retractor**  
IS-18-25318 18.0 cm, 7 prongs





## Retractors

**IS-18-25438** **Gorney Rake**  
7.5 cm, retractor with spring, 38mm wide



**IS-42-37613** **Rollet**  
13.0 cm, retractor, delicate,  
4 sharp prongs



**IS-18-26513** **Miller Rake**  
13.5 cm, tissue retractor, delicate,  
9 sharp prongs



**IS-18-24214** **Ragnell**  
15.0 cm, double ended retractor,  
delicate



**IS-18-24314** **Ragnell-Davis**  
14.5 cm,  
double ended retractor





## Retractors



- IS-18-16017** **Senn**  
17.0 cm,  
double ended retractor, sharp
- IS-18-16117**  
17.0 cm,  
double ended retractor,  
blunt



- IS-18-63510** **Holtzheimer**  
self retaining retractor, 4 teeth  
10.0 cm, blunt, straight
- IS-18-63410**  
10.0 cm, sharp, straight
- IS-18-63710**  
10.0 cm, blunt, curved
- IS-18-63610**  
10.0 cm, sharp, curved



- IS-18-80120** **Farr Spring Retractor**  
14.0 cm x 2.0 cm
- IS-18-80121**  
14.0 cm x 3.0 cm

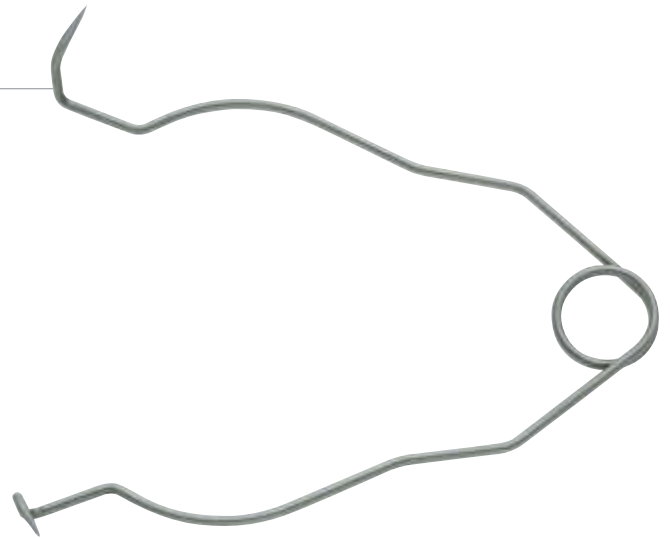



## Retractors

**IS-18-24316** **Kasden**  
16.5 cm,  
double ended retractor



**IS-18-23908** **Kawamoto**  
16.0 cm,  
double ended retractor,  
insulated, 8mm/10mm blades



**IS-18-23914** **Kawamoto**  
16.0 cm,  
double ended retractor,  
insulated, 14mm/16mm blades



**IS-48-58716** **Wise**  
16.5 cm, orbit retractor,  
double ended



**IS-48-90301** **Hajek's**  
18.0 cm, cheek retractor





## Retractors





## Retractors

IS-48-32400

**Dingman Mouth Gag complete**  
16.6 cm frame, 3 tongue blades

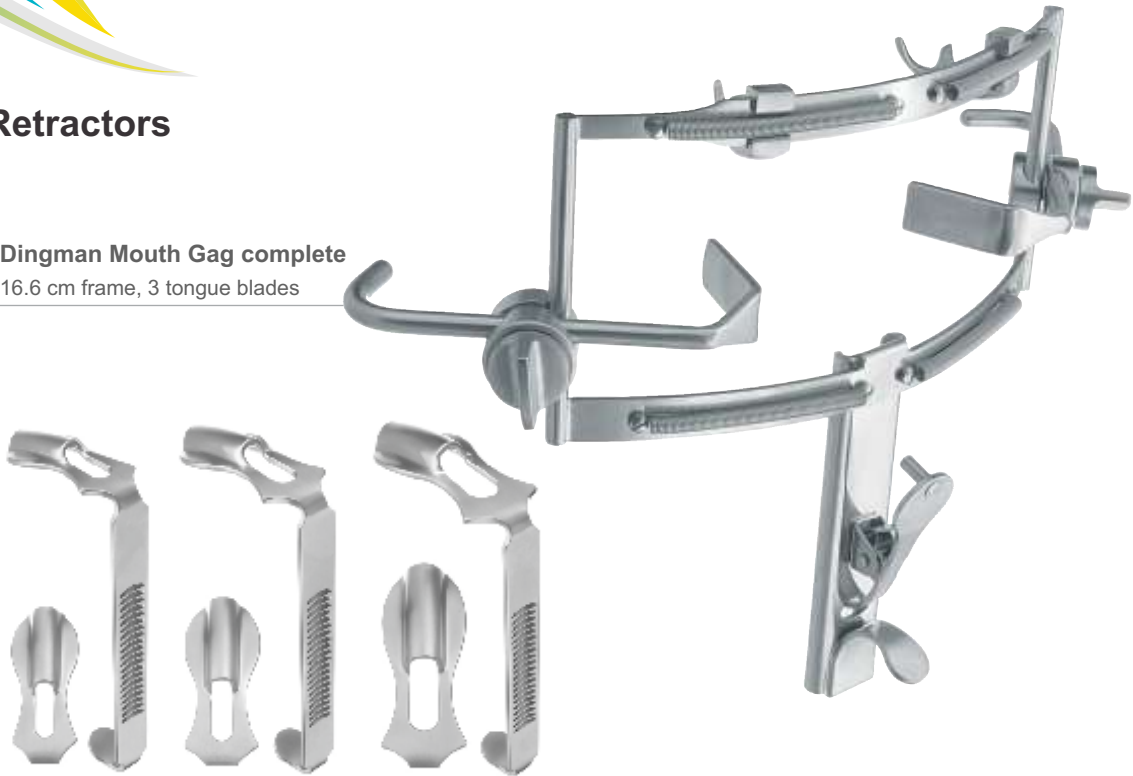

IS-32-45001  
IS-32-45002

**Lead Hand**  
adult size  
child size





## Breast Retractors



**IS-38-30133** 33.0 cm, angled  
**IS-38-30142** 42.0 cm, angled



**IS-38-30233** 33.0 cm, angled, malleable  
**IS-38-30242** 42.0 cm, angled, malleable



**IS-38-30333** 33.0 cm, angled, insulated  
**IS-38-30342** 42.0 cm, angled, insulated





## Breast Retractors

**IS-38-31133**

33.0 cm,  
spatulated

**IS-38-31142**

42.0 cm,  
spatulated

**IS-38-31233**

33.0 cm,  
spatulated, malleable

**IS-38-31242**

42.0 cm, spatulated,  
malleable

**IS-38-31333**

33.0 cm,  
spatulated, insulated

**IS-38-31342**

42.0 cm, spatulated,  
insulated

**IS-38-31432**

32.0 cm,  
oval spatulated  
blade

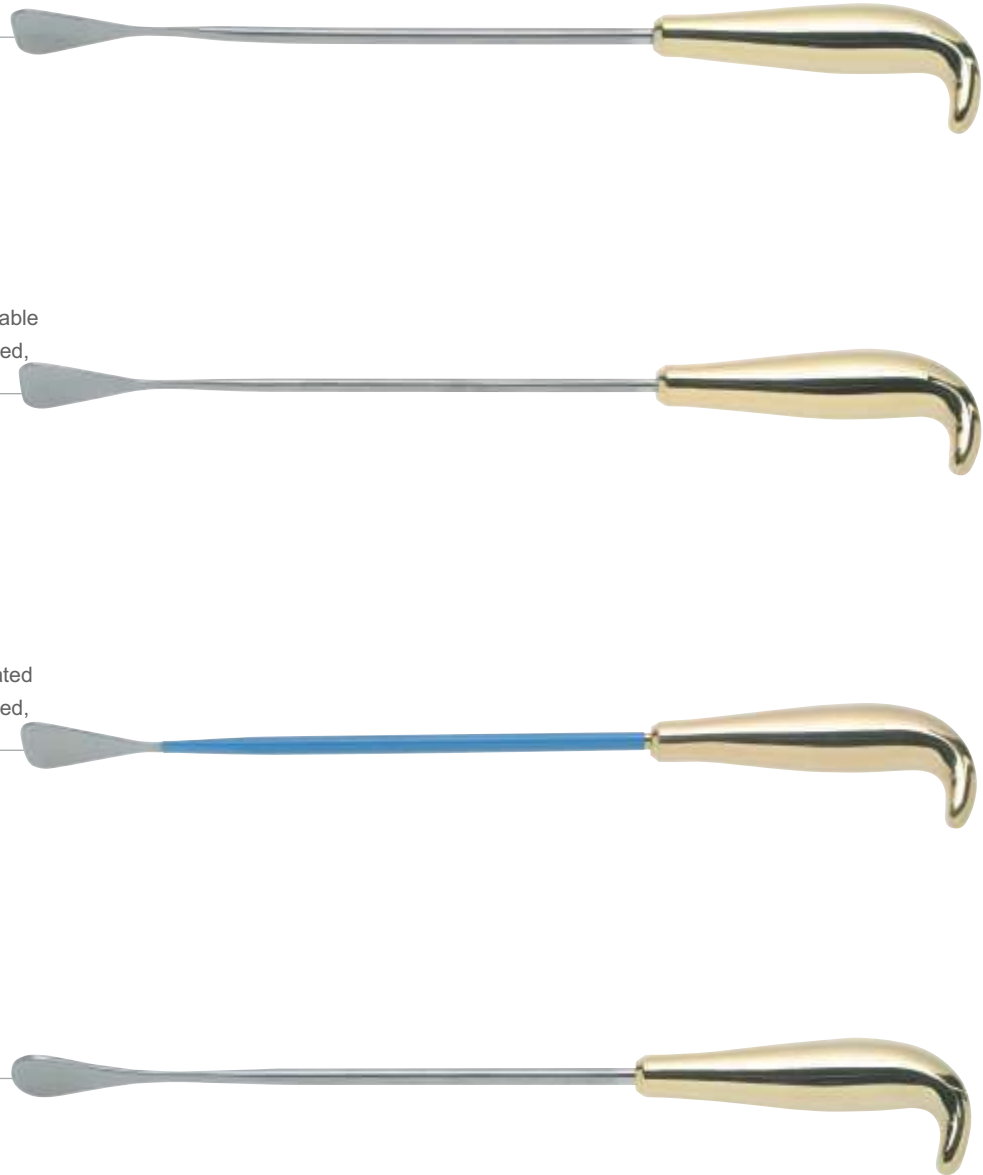



## Shaper



- IS-38-32001** **Scalp Dissector**  
24.0 cm, slightly curved, 12.5 mm wide
- IS-38-32011**  
24.0 cm, slightly curved, 12.5 mm wide,  
with Ergo Handle



- IS-38-32002** **Scalp Dissector**  
24.0 cm, half curved, with angled tip,  
12.5 mm wide
- IS-38-32012**  
24.0 cm, half curved, with angled tip,  
12.5 mm wide, with Ergo Handle



- IS-38-32003** **Dissector**  
24.0 cm, half curved, 7.0 mm wide
- IS-38-32013**  
24.0 cm, half curved, 7.0 mm wide,  
with Ergo Handle



- IS-38-32004** **Transoral Dissector**  
23.5 cm, curved, 7.0 mm wide
- IS-38-32014**  
23.5 cm, curved, 7.0 mm wide,  
with Ergo Handle



- IS-38-32005** **Dissector**  
24.0 cm, straight, 7.0 mm wide
- IS-38-32015**  
24.0 cm, straight, 7.0 mm wide,  
with Ergo Handle





## Shaper

- IS-38-32006** **Flap Dissector**  
24.0 cm, curved, 6.5 mm wide
- IS-38-32016** **Flap Dissector**  
24.0 cm, curved, 6.5 mm wide,  
with Ergo Handle



- IS-38-32007** **Frontoglobellar Dissector**  
26.5 cm, S-shaped
- IS-38-32017** **Frontoglobellar Dissector**  
26.5 cm, S-shaped,  
with Ergo Handle

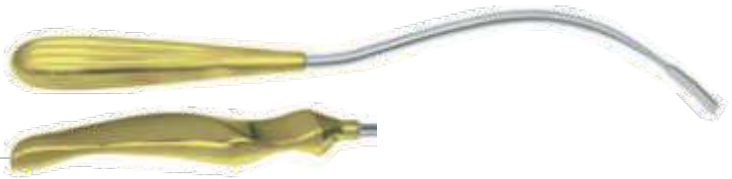

- IS-38-32008** **Midface Fascia Dissector**  
24.0 cm, S-shaped
- IS-38-32018** **Midface Fascia Dissector**  
24.0 cm, S-shaped,  
with Ergo Handle



- IS-38-32009** **Flap Dissector**  
22.5 cm, straight, 10 mm wide
- IS-38-32019** **Flap Dissector**  
22.5 cm, straight, 10 mm wide,  
with Ergo Handle



- IS-38-32101** **Periosteal Dissector**  
24.0 cm, S-shaped, 9 mm wide
- IS-38-32111** **Periosteal Dissector**  
24.0 cm, S-shaped, 9 mm wide,  
with Ergo Handle





## Shaper



<b>IS-38-32102</b>	<b>Nerve Dissector</b> 24.0 cm, slightly curved	
<b>IS-38-32112</b>	24.0 cm, slightly curved, with Ergo Handle	
<b>IS-38-32103</b>	<b>Orbital Rim Dissector</b> 24.0 cm, half curved	
<b>IS-38-32113</b>	24.0 cm, half curved, with Ergo Handle	
<b>IS-38-32104</b>	<b>Temporal Dissector</b> 23.5 cm, straight	
<b>IS-38-32114</b>	23.5 cm, straight, with Ergo Handle	
<b>IS-38-32105</b>	<b>Periosteal Dissector</b> 25.0 cm, curved	
<b>IS-38-32115</b>	25.0 cm, curved, with Ergo Handle	



## Shaper

**IS-38-33001** Nerve Hook  
24.0 cm, curved right  
**IS-38-33002** 24.0 cm, curved left



**IS-38-33123** Nerve Hook  
23.5 cm, slightly malleable,  
with graduation



**IS-38-33501** Nerve Protector  
17.0 cm, curved right  
**IS-38-33502** 17.0 cm, curved left



**IS-38-34001** Suction Elevator  
slightly curved, round edge



**IS-38-35023** Scalpel Handle  
23.0 cm,  
for small blades, downwards angled





## Osteotomes



**Anderson-Neivert**  
IS-46-46907 20.0 cm, straight  
IS-46-46917 20.0 cm, right  
IS-46-46927 20.0 cm, left

**Gunter**  
IS-46-46307 21.5 cm, straight  
IS-46-46317 21.5 cm, right  
IS-46-46327 21.5 cm, left

**Silver**  
rhinoplastic chisel  
IS-46-47301 18.0 cm, straight  
IS-46-47302 18.0 cm, right  
IS-46-47303 18.0 cm, left

**Ristow**  
IS-46-47701 20.5 cm, right  
IS-46-47702 20.5 cm, left

**Rees**  
handle aluminium anodized  
IS-46-44802 20.5 cm, 2 mm  
IS-46-44803 20.5 cm, 3 mm





## Osteotomes

### Parkes

IS-46-47518

16.0 cm, straight



### Converse

IS-46-47102

18.0 cm, 2 mm

IS-46-47103

18.0 cm, 3 mm

IS-46-47104

18.0 cm, 4 mm

IS-46-47105

18.0 cm, 5 mm

IS-46-47106

18.0 cm, 6 mm

IS-46-47107

18.0 cm, 7 mm

IS-46-47108

18.0 cm, 8 mm

IS-46-47109

18.0 cm, 9 mm

IS-46-47110

18.0 cm, 10 mm

IS-46-47111

18.0 cm, 11 mm

IS-46-47112

18.0 cm, 12 mm

IS-46-47115

18.0 cm, 15 mm



### Sheehan

IS-46-46702

16.0 cm, 2 mm

IS-46-46703

16.0 cm, 3 mm

IS-46-46704

16.0 cm, 4 mm

IS-46-46705

16.0 cm, 5 mm

IS-46-46706

16.0 cm, 6 mm

IS-46-46709

16.0 cm, 9 mm

IS-46-46710

16.0 cm, 10 mm





## Osteotomes



### Cinelli

- IS-46-47210 18.5 cm, 10 mm
- IS-46-47212 18.5 cm, 12 mm
- IS-46-47214 18.5 cm, 14 mm
- IS-46-47216 18.5 cm, 16 mm



### Rubin Type

- IS-46-46810 17.0 cm, 10 mm
- IS-46-46814 17.0 cm, 14 mm
- IS-46-46816 17.0 cm, 16 mm



### Parkes Gouge

- IS-46-47918 18.0 cm, 6.5 mm



### Sheen angled, Radix Chisel

- IS-46-44710 18.0 cm, 10 mm, 10° angle
- IS-46-44720 18.0 cm, 10 mm, 20° angle



### Freer Chisel

- IS-46-45004 16.5 cm, 4 mm, straight





## Mallets

**IS-32-69632**  
**IS-32-69702**

**Mead**  
17.0 cm, 320 g  
pair of interchangeable faces



**IS-32-69114**

**Nylon**  
18.5 cm, head Nylon / Nylon



**IS-32-69214**

**Nylon**  
18.5 cm, head Nylon / Stainless



**IS-32-68625**

**Gerzog**  
18.0 cm, 250 g = 8 oz





## Morselizers



**IS-46-25318** **Gunter**  
18.0 cm, serrated, TC



**IS-46-25520** **Gorney**  
18.5 cm, straight



**IS-46-53800** **Cottle**  
cartilage-crusher, including forceps for removal





## Saws

### Joseph Saw

- IS-46-53219 19.0 cm, left bayonet
- IS-46-53419 19.0 cm, right bayonet



## Curettes

### Converse double ended curette

- IS-44-76321 21.0 cm, 7.0 x 10.0 and 6.5 x 8.5mm



### Fox dermal curette

- IS-74-12803 14.0 cm, 3 mm oval
- IS-74-12804 14.0 cm, 4 mm oval
- IS-74-12805 14.0 cm, 5 mm oval



## Septum Forceps

### Asch straightening Forceps

- IS-46-57123 23.0 cm



### Walsham straightening Forceps

- IS-46-57223 23.0 cm, straight
- IS-46-57323 23.0 cm, left
- IS-46-57523 23.0 cm, right





## Nasal Speculas



- Vienna**
- IS-46-11201** 14.0 cm, for baby
  - IS-46-11202** 14.0 cm, for child
  - IS-46-11203** 14.0 cm, for adult



- Killian**
- IS-46-12035** 13.0 cm, 35 mm
  - IS-46-12050** 13.0 cm, 50 mm
  - IS-46-12075** 13.0 cm, 75 mm
  - IS-46-12090** 13.0 cm, 90 mm



- Cottle**
- IS-46-12435** 14.0 cm, 35 mm
  - IS-46-12450** 14.0 cm, 50 mm
  - IS-46-12475** 14.0 cm, 75 mm
  - IS-46-12490** 14.0 cm, 90 mm





## Elevators

**IS-32-81921** **Rowe's**  
21.0 cm,  
Zygomatic bone elevator



**IS-46-43124** **McCulloch**  
24.0 cm, double ended blunt  
elevator, 4.2 mm



**IS-46-40119** **Gorney Suction**  
19.0 cm, round end,  
suction-elevator



**IS-46-42123** **Cottle Septum**  
23.0 cm



**IS-46-42516** **Joseph**  
16.5 cm, periosteal elevator





## Elevators



- |                    |   |  |
|--------------------|---|--|
| <b>IS-46-41645</b> | <b>Freer</b><br>19.0 cm, tip 4.5 mm,<br>sharp/blunt                           |    |
| <b>IS-46-41665</b> | 19.0 cm, tip 6.5 mm,<br>sharp/blunt   |    |
| <b>IS-46-40418</b> | <b>McCollough</b><br>18.5 cm  |    |
| <b>IS-46-50318</b> | <b>Woodson</b><br>20.0 cm   |  |
| <b>IS-46-42519</b> | <b>Cottle Skin</b><br>19.0 cm, 10 mm wide                                     |  |
| <b>IS-46-43317</b> | <b>Mitchells Trimmer</b><br>17.0 cm, knife blade and spoon<br>shaped elevator |  |



## Elevators

**Obwegeser Periosteal**  
IS-48-69907 18.0 cm, 7 mm  
IS-48-69911 18.0 cm, 11 mm



**Boies**  
IS-46-57719 19.5 cm



**Carlin**  
IS-48-56600 15.5 cm, chin implant  
periosteal elevator



**Clodius**  
IS-48-58500 orbital retractor, double ended,  
13 mm / 20 mm





## Hooks



**Frazier Skin Hook**  
**IS-18-21413** 13.0 cm, sharp  
**IS-18-21418** 18.0 cm, sharp



**O'Conner Iris Skin Hook**  
**IS-18-20913** 12.5 cm, sharp



**Converse Skin Hook**  
**IS-18-20501** 19.0 cm, small  
**IS-18-20503** 19.0 cm, large



**Joseph Skin Hook**  
**IS-18-21601** 16.0 cm, single hook  
**IS-18-21602** 16.0 cm, 2 mm double hook  
**IS-18-21605** 16.0 cm, 5 mm double hook  
**IS-18-21607** 16.0 cm, 7 mm double hook  
**IS-18-21610** 16.0 cm, 10 mm double hook



**Kleinert-Kutz Hook**  
**IS-18-20803** 16.0 cm, 3 mm  
**IS-18-20805** 16.0 cm, 5 mm  
**IS-18-20807** 16.0 cm, 7 mm





## Hooks

**IS-46-55218** **Millard Thimble Hook**  
18 mm wide, double hook



**IS-46-55701** **Cottle Tenaculum**  
15.0 cm, Fig. 1  
**IS-46-55702** 15.0 cm, Fig. 2  
**IS-46-55703** 15.0 cm, Fig. 3



**IS-18-21201** **Guthrie Double Hook**  
12.0 cm, 2.5 mm  
**IS-18-21202** 12.0 cm, 3.0 mm



**IS-18-20413** **Tyrell Skin Hook**  
13.0 cm



**IS-46-56018** **Gillies Skin Hook**  
18.0 cm, Fig. 1  
**IS-46-56218** 18.0 cm, Fig. 2



**IS-46-56614** **Barsky Double Skin Hook**  
15.0 cm, 5 mm





## Measuring



IS-02-31911

**Thorpe Precision Caliper**  
12.5 cm



IS-42-58307

**Castroviejo Caliper**  
9.0 cm



IS-02-31710

**Jameson Caliper**  
10.0 cm



IS-02-31811

**Thorpe Caliper, angled**  
12.0 cm





## Dissectors

**IS-38-16033** Dissector Spatulated  
33.0 cm



**IS-38-15536** Agris-Dingman  
36.0 cm,  
with scale, pair = left + right



**IS-38-15041** McCollum-Dingman  
41.0 cm,  
breast dissector



**IS-38-15030** McCollum-Dingman  
30.0 cm, submammary dissector



## Markers



**Grossmann**  
Areola Marker  
4 sizes

**IS-38-10400**



**Freeman**  
Areola Marker

**IS-38-10534** 34 mm  
**IS-38-10536** 36 mm  
**IS-38-10538** 38 mm  
**IS-38-10542** 42 mm  
**IS-38-10545** 45 mm  
**IS-38-10550** 50 mm

**IS-38-10534**  
**IS-38-10536**  
**IS-38-10538**  
**IS-38-10542**  
**IS-38-10545**  
**IS-38-10550**



**McKissock "keyhole"**  
used in conjunction  
with Freeman Areola Marker

**IS-38-11038** 38 mm  
**IS-38-11042** 42 mm  
**IS-38-11045** 45 mm

**IS-38-11038**  
**IS-38-11042**  
**IS-38-11045**



**Freeman**  
38/42 mm diameter  
42/45 mm diameter

**IS-38-10738**  
**IS-38-10742**

**IS-38-10738**  
**IS-38-10742**



**Ackerman**  
Areola Marker

**IS-38-11414** 10.0 cm  
**IS-38-11416** 11.5 cm

**IS-38-11414**  
**IS-38-11416**

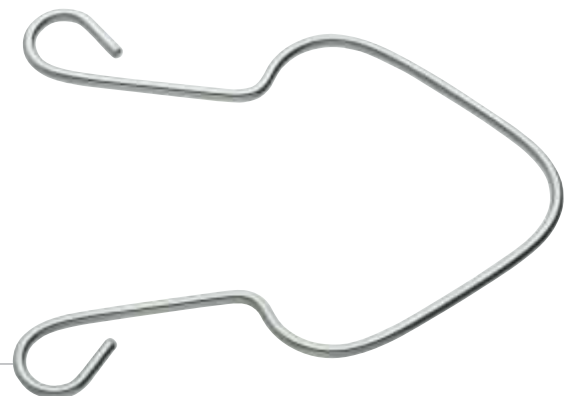



## Markers

**IS-38-20216** D'Assumpcao F/L 16.0 cm  
**IS-38-20316** 16.0 cm, with ratchet



**IS-38-20916** Pitanguy Flap Demarcator 16.0 cm, facial



**IS-38-20714** Marten Flap 14.5 cm  
**IS-38-20614** 14.5 cm, with ratchet





## Forceps



**Hartmann Mosquito**  
IS-12-21010 10.0 cm, straight  
IS-12-21110 10.0 cm, curved



**Halstead Mosquito**  
IS-12-23012 12.5 cm, straight, 1x2 teeth  
IS-12-23112 12.5 cm, curved, 1x2 teeth  
IS-12-22012 12.5 cm, straight  
IS-12-22112 12.5 cm, curved



**Kelly**  
IS-12-24014 14.0 cm, straight  
IS-12-24114 14.0 cm, curved



**Crile**  
hemostatic forceps  
IS-12-25014 14.0 cm, straight  
IS-12-25114 14.0 cm, curved  
IS-12-26316 16.0 cm, curved





## Forceps

### Rochester Pean hemostatic forceps

- IS-12-31014** 14.0 cm, straight
- IS-12-31016** 16.0 cm, straight
- IS-12-31020** 20.0 cm, straight
- IS-12-31116** 16.0 cm, curved
- IS-12-31118** 18.0 cm, curved
- IS-12-31120** 20.0 cm, curved

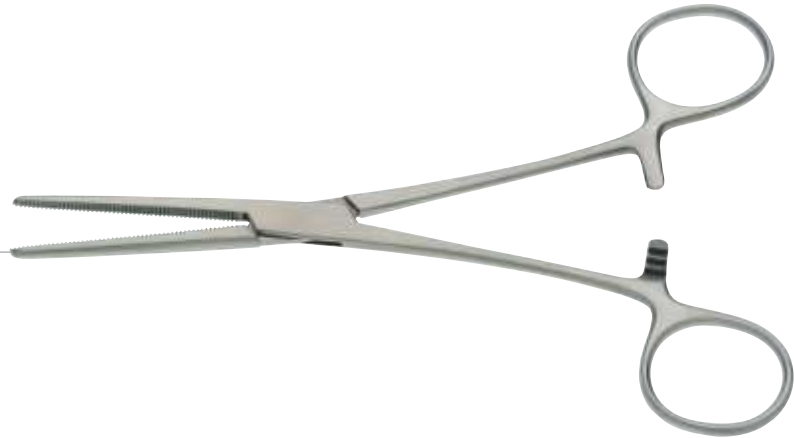

### Rochester-Ochsner hemostatic forceps

- IS-12-32014** 14.0 cm, straight, 1x2 teeth
- IS-12-32114** 14.0 cm, curved, 1x2 teeth
- IS-12-32016** 16.0 cm, straight, 1x2 teeth
- IS-12-32116** 16.0 cm, curved, 1x2 teeth



### Adson hemostatic forceps

- IS-12-41018** 18.5 cm, straight
- IS-12-41118** 18.5 cm, curved





## Forceps



**Lahey Vulsellum**  
IS-54-52015 15.0 cm  
IS-54-52020 20.0 cm



**Allis**  
IS-64-10214 14.0 cm, 4:5 teeth, Allis Baby  
IS-64-11015 15.0 cm, 4:5 teeth  
IS-64-12015 15.0 cm, 5:6 teeth  
IS-64-12019 19.0 cm, 5:6 teeth



**Backhaus Towel**  
IS-14-11109 9.0 cm  
IS-14-11111 11.0 cm  
IS-14-11113 13.0 cm  
IS-14-11115 15.0 cm





## Forceps

IS-14-12111  
IS-14-12113

**Lorna Towel**  
11.0 cm  
13.0 cm



IS-14-10309

**Jones Towel**  
9.0 cm



IS-16-17018  
IS-16-17020  
IS-16-17025

**Foerster Sponge Holding**  
18.0 cm  
20.0 cm  
25.0 cm





## Knives



- IS-46-39003** 20.0 cm, straight, 3 mm blade
- IS-46-39004** 20.0 cm, straight, 4 mm blade
- IS-46-39005** 20.0 cm, straight, 5 mm blade
- IS-46-39203** 20.0 cm, bayonet, 3 mm blade
- IS-46-39204** 20.0 cm, bayonet, 4 mm blade
- IS-46-39205** 20.0 cm, bayonet, 5 mm blade

### Ballenger Swivel



### Freer Mucosa Knife

- IS-46-37415** 15.0 cm, "D" pattern



### Silver Dermatome

- IS-06-48219** 19.0 cm





## Knives

**IS-06-48230**  
**IS-06-48401**

### Watson Dermatome

30.0 cm, complete  
spare blade (1pc.)



**IS-38-14027**

### Foerster

27.0 cm,  
capsulotomy knife



**IS-06-10303**

### Scalpel Handle

14.5 cm, Fig. 3, round



**IS-06-10301**

### Scalpel Handle No. 3

12.0 cm, with cm-graduation





## Rongeurs



**IS-32-15016**    **Lempert**    16.0 cm, straight  
**IS-32-15116**    16.0 cm, curved



**IS-32-20118**    **Beyer**    18.0 cm, curved





## Bone Cutting Forceps

**IS-46-32519** **Jansen Middleton**  
nasal cutting forceps  
19.5 cm



**IS-46-21002** **Takahashi Cutting Forceps**  
11.5 cm, working length, 2.5x8 mm bite



**IS-32-28314** **Kleinert-Kutz Forceps**  
14.0 cm, straight  
**IS-32-28414** 14.0 cm, curved





## Miscellaneous

### Ruler

graduated in mm and inches

<b>IS-02-34010</b>	10.0 cm
<b>IS-02-34020</b>	20.0 cm
<b>IS-02-34030</b>	30.0 cm
<b>IS-02-34050</b>	50.0 cm



### Barron Suction Tubes

<b>IS-44-10103</b>	13.0 cm, 3 french
<b>IS-44-10105</b>	13.0 cm, 5 french
<b>IS-44-10107</b>	13.0 cm, 7 french



### Yankauer Aspiration Tube

27.0 cm, complete  
with suction tip  
and connector

**IS-04-15027**





## Miscellaneous

**IS-33-53820** **Universal Flat Nose Pliers**  
20.0 cm



**IS-33-53202** **Wire Seizing Forceps**  
18.0 cm, 4 mm  
**IS-33-53203** 18.0 cm, 6 mm



**IS-33-56814** **Needle Nose Pliers**  
14.0 cm, cross-serrated





## Miscellaneous



**IS-33-53803** General Purpose Pliers  
18.0 cm



**IS-33-54717** Wire/Pin Cutter  
18.0 cm, 1.7 wire, TC  
**IS-33-54522** 22.0 cm, 2.5 wire, TC



**IS-33-54618** Wire/Pin Cutter  
18.0 cm, TC





## Cannulas / Lipo Suction

### Lipo Hand piece

with lever mechanism,  
quick lock mechanism

IS-38-40010



with thumb control,  
quick lock mechanism

IS-38-40020



### Triport

working length    Ø

IS-38-41315	150 mm	3 mm
IS-38-41320	200 mm	3 mm
IS-38-41325	250 mm	3 mm
IS-38-41330	300 mm	3 mm
IS-38-41420	200 mm	4 mm
IS-38-41425	250 mm	4 mm
IS-38-41430	300 mm	4 mm
IS-38-41525	250 mm	5 mm
IS-38-41530	300 mm	5 mm



### Monoport

working length    Ø

IS-38-42315	150 mm	3 mm
IS-38-42320	200 mm	3 mm
IS-38-42325	250 mm	3 mm
IS-38-42330	300 mm	3 mm
IS-38-42420	200 mm	4 mm
IS-38-42425	250 mm	4 mm
IS-38-42430	300 mm	4 mm
IS-38-42525	250 mm	5 mm
IS-38-42530	300 mm	5 mm





## Cannulas / Lipo Suction



	<b>Cobra</b>		
	working length		Ø
<b>IS-38-43315</b>	150 mm		3 mm
<b>IS-38-43320</b>	200 mm		3 mm
<b>IS-38-43325</b>	250 mm		3 mm
<b>IS-38-43420</b>	200 mm		4 mm
<b>IS-38-43425</b>	250 mm		4 mm
<b>IS-38-43430</b>	300 mm		4 mm
<b>IS-38-43525</b>	250 mm		5 mm
<b>IS-38-43530</b>	300 mm		5 mm



	<b>Spirale</b>		
	working length		Ø
<b>IS-38-44315</b>	150 mm		3 mm
<b>IS-38-44320</b>	200 mm		3 mm
<b>IS-38-44325</b>	250 mm		3 mm
<b>IS-38-44420</b>	200 mm		4 mm
<b>IS-38-44425</b>	250 mm		4 mm
<b>IS-38-44430</b>	300 mm		4 mm
<b>IS-38-44525</b>	250 mm		5 mm
<b>IS-38-44530</b>	300 mm		5 mm



	<b>Shark</b>		
	working length		Ø
<b>IS-38-45315</b>	150 mm		3 mm
<b>IS-38-45320</b>	200 mm		3 mm
<b>IS-38-45325</b>	250 mm		3 mm
<b>IS-38-45420</b>	200 mm		4 mm
<b>IS-38-45425</b>	250 mm		4 mm
<b>IS-38-45430</b>	300 mm		4 mm
<b>IS-38-45525</b>	250 mm		5 mm
<b>IS-38-45530</b>	300 mm		5 mm





## Cannulas / Lipo Suction

**Lipo Hand piece**  
with thumb control,  
luer lock

IS-38-40030



**Triport**

working length    Ø

IS-38-46320	200 mm	3 mm
IS-38-46325	250 mm	3 mm
IS-38-46420	200 mm	4 mm
IS-38-46425	250 mm	4 mm
IS-38-46430	300 mm	4 mm
IS-38-46525	250 mm	5 mm
IS-38-46530	300 mm	5 mm



**Mercedes**

working length    Ø

IS-38-47320	200 mm	3 mm
IS-38-47325	250 mm	3 mm
IS-38-47420	200 mm	4 mm
IS-38-47425	250 mm	4 mm
IS-38-47430	300 mm	4 mm
IS-38-47525	250 mm	5 mm
IS-38-47530	300 mm	5 mm



**Spirale**

working length    Ø

IS-38-48320	200 mm	3 mm
IS-38-48325	250 mm	3 mm
IS-38-48420	200 mm	4 mm
IS-38-48425	250 mm	4 mm
IS-38-48430	300 mm	4 mm
IS-38-48525	250 mm	5 mm
IS-38-48530	300 mm	5 mm





*Liposuction*  
**Instruments Catalogue**  
[www.instrumexsurgical.com](http://www.instrumexsurgical.com)



**INSTRUMEX**SURGICAL  
**I N S T R U M E N T S**



*Liposuction*  
**Instruments Catalogue**



# Liposuction Cannula Handles



## **BLACK HANDLE**

Product Code: BLK

### Product Description:

Black Handle

Handle made of aluminum with type 2 black anodized, 6.65" length 1" diameter



## **BLUE HANDLE**

Product Code: BH

### Product Description:

BLUE Handle

Handle made of aluminum with type 2 blue anodized, 6.65" length 1" diameter



## **GOLD HANDLE**

Product Code: GH

### Product Description:

Gold Handle

Handle made of aluminum with type 2 gold anodized, 6.65" length 1" diameter



## **HANDLE w/SWIVEL BARB**

Product Code: LH/S

Product Code: LH/S

### Product Description:

Handle made of aluminum with type 2 blue anodized, 6.65" length, 1" diameter for Large Handle, 3/4" for Small Handle)



## **HANDLE**

Product Code: LH

Product Code: SH

### Product Description:

Handle made of aluminum with type 2 blue anodized, 6.65" length 1" diameter for Large Handle, 3/4" for Small Handle





## Liposuction Cannula Handles (cont.)

### **STAINLESS STEEL TOOMEY 60cc HUB**

Product Code: T60SS

Product Description:

Stainless Steel and Stainless Steel hub

### **ALUMINUM TOOMEY 60cc HUB**

Product Code: T60AL

Product Description:

Hub made of Aluminum with type 2 blue anodized, 1.55" length 1.31" diameter

### **QUICK SCREW HUB**

Product Code: QSH

Product Description:

Hub made of Stainless Steel, 2.1" length 7/8" diameter

### **SMALL QUICK DISCONNECT HUB**

Product Code: QSH

Product Description:

Hub made of Stainless Steel, 1.93" length 5/8" diameter

### **QUICK DISCONNECT HUB**

Product Code: QDH

Product Description:

Hub made of Stainless Steel, 1.6" length 7/8" diameter

### **QUICK LOCK HUB**

Product Code: QLH

Product Description:

Hub made of Stainless Steel, 1.65" length 1/2" diameter

### **LUER LOCK HUB**

Product Code: LL

Product Description:

Luer Lock Hub

Hub made of Stainless Steel, 1.16" length 3/8" diameter



# Cannula Hole Pattern



## **MERCEDES**

Product Code: **2010 MER**  
Available Diameter & Length  
Diameter: 16ga, 15ga, 14ga, 13ga, 12ga, 3mm,  
4mm, 5mm.  
Length: 15cm, 23cm, 26cm, 30cm, 32cm.



## **TRI PORT**

Product Code: **2020 III**  
Available Diameter & Length  
Diameter: 16ga, 15ga, 14ga, 13ga, 12ga, 3mm,  
4mm, 5mm.  
Length: 15cm, 23cm, 26cm, 30cm, 32cm.



## **LAS VEGAS**

Product Code: **2030 LV**  
Available Diameter & Length  
Diameter: 16ga, 15ga, 14ga, 13ga, 12ga, 3mm,  
4mm, 5mm.  
Length: 15cm, 23cm, 26cm, 30cm, 32cm.



## **STANDARD 3 PORT**

Product Code: **2050 STD3**  
Available Diameter & Length  
Diameter: 16ga, 15ga, 14ga, 13ga, 12ga, 3mm,  
4mm, 5mm.  
Length: 15cm, 23cm, 26cm, 30cm, 32cm.



## **STANDARD 2 PORT**

Product Code: **2055 STD2**  
Available Diameter & Length  
Diameter: 16ga, 15ga, 14ga, 13ga, 12ga, 3mm,  
4mm, 5mm.  
Length: 15cm, 23cm, 26cm, 30cm, 32cm.





## Cannula Hole Pattern (cont.)



### **STANDARD SINGLE PORT**

Product Code: **2060 STD**

Available Diameter & Length

Diameter: 16ga, 15ga, 14ga, 13ga, 12ga, 3mm, 4mm, 5mm.

Length: 15cm, 23cm, 26cm, 30cm, 32cm.



### **3 PORT 60 DEGREE INDEX**

Product Code: **2070 GF**

Available Diameter & Length

Diameter: 16ga, 15ga, 14ga, 13ga, 12ga, 3mm, 4mm, 5mm.

Length: 15cm, 23cm, 26cm, 30cm, 32cm.



### **3 PORT 60 DEGREE INDEX**

Product Code: **2070 GF**

Available Diameter & Length

Diameter: 16ga, 15ga, 14ga, 13ga, 12ga, 3mm, 4mm, 5mm.

Length: 15cm, 23cm, 26cm, 30cm, 32cm.



### **BASKET**

Product Code: **2090 BAS**

Available Diameter & Length

Diameter: 16ga, 15ga, 14ga, 13ga, 12ga, 3mm, 4mm, 5mm.

Length: 15cm, 23cm, 26cm, 30cm, 32cm.



### **SPATULA**

Product Code: **2100 SPA**

Available Diameter & Length

Diameter: 16ga, 15ga, 14ga, 13ga, 12ga, 3mm, 4mm, 5mm.

Length: 15cm, 23cm, 26cm, 30cm, 32cm.

# Cannula Hole Pattern (cont.)



### SPATULA 2 PORT

Product Code: **2105 SP2**  
 Available Diameter & Length  
 Diameter: 16ga, 15ga, 14ga, 13ga, 12ga, 3mm, 4mm, 5mm.  
 Length: 15cm, 23cm, 26cm, 30cm, 32cm.



### SPATULA 3 PORT

Product Code: **2110 SPA3**  
 Available Diameter & Length  
 Diameter: 16ga, 15ga, 14ga, 13ga, 12ga, 3mm, 4mm, 5mm.  
 Length: 15cm, 23cm, 26cm, 30cm, 32cm.



### SPATULA 3 PORT

Product Code: **2110 SPA3**  
 Available Diameter & Length  
 Diameter: 16ga, 15ga, 14ga, 13ga, 12ga, 3mm, 4mm, 5mm.  
 Length: 15cm, 23cm, 26cm, 30cm, 32cm.



### COBRA

Product Code: **2130 COB**  
 Available Diameter & Length  
 Diameter: 16ga, 15ga, 14ga, 13ga, 12ga, 3mm, 4mm, 5mm.  
 Length: 15cm, 23cm, 26cm, 30cm, 32cm.



### FUENTES

Product Code: **2320 FUE**  
 Available Diameter & Length  
 Diameter: 16ga, 15ga, 14ga, 13ga, 12ga, 3mm, 4mm, 5mm.  
 Length: 15cm, 23cm, 26cm, 30cm, 32cm.





## Cannula Hole Pattern (cont.)



### **SAYLAN**

Product Code: **2140 SAY**

Available Diameter & Length

Diameter: 16ga, 15ga, 14ga, 13ga, 12ga, 3mm, 4mm, 5mm.

Length: 15cm, 23cm, 26cm, 30cm, 32cm.



### **CANDY CANE**

Product Code: **2160 CC**

Available Diameter & Length

Diameter: 16ga, 15ga, 14ga, 13ga, 12ga, 3mm, 4mm, 5mm.

Length: 15cm, 23cm, 26cm, 30cm, 32cm.



### **MODERN SPIRAL**

Product Code: **2170 MS**

Available Diameter & Length

Diameter: 16ga, 15ga, 14ga, 13ga, 12ga, 3mm, 4mm, 5mm.

Length: 15cm, 23cm, 26cm, 30cm, 32cm.



### **TOLEDO SINGLE PORT**

Product Code: **2190 TOL**

Available Diameter & Length

Diameter: 16ga, 15ga, 14ga, 13ga, 12ga, 3mm, 4mm, 5mm.

Length: 15cm, 23cm, 26cm, 30cm, 32cm.



# Infiltration Cannulas



## **GARDEN SPRAY ANESTHESIA NEEDLE**

Product Code: **2260 GAN**

Available Diameter & Length

Diameter: 18ga, 17ga, 16ga, 15ga, 14ga, 13ga, 12ga, 3mm, 4mm.

Length: 15cm, 23cm, 26cm, 30cm, 32cm.



## **MULTI HOLE SPRAY NEEDLE**

Product Code: **2250 MHS**

Available Diameter & Length

Diameter: 18ga, 17ga, 16ga, 15ga, 14ga, 13ga, 12ga, 3mm, 4mm.

Length: 15cm, 23cm, 26cm, 30cm, 32cm.



## **BODY ANESTHESIA NEEDLE**

Product Code: **2270 BAN**

Available Diameter & Length

Diameter: 18ga, 17ga, 16ga, 15ga, 14ga, 13ga, 12ga, 3mm, 4mm.

Length: 15cm, 23cm, 26cm, 30cm, 32cm.



## **Infusion 6 hole Needle**

Product Code: **2266 INFU6**

Available Diameter & Length

Diameter: 18ga, 17ga, 16ga, 15ga, 14ga, 13ga, 12ga, 3mm, 4mm.

Length: 15cm, 23cm, 26cm, 30cm, 32cm.



## **Infusion 8 hole Needle**

Product Code: **2268 INFU8**

Available Diameter & Length

Diameter: 18ga, 17ga, 16ga, 15ga, 14ga, 13ga, 12ga, 3mm, 4mm.

Length: 15cm, 23cm, 26cm, 30cm, 32cm.





## Reinjection Micro Cannula



### **MICRO INJECTION NEEDLE, STYLE 3**

Product Code: **2235 MIN3**

Available Diameter & Length  
Diameter: 18ga, 17ga, 16ga, 15ga, 14ga, 13ga, 12ga, 3mm, 4mm.  
Length: 15cm, 23cm, 26cm.



### **MICRO INJECTION NEEDLE, STYLE 2**

Product Code: **2230 MIN2**

Available Diameter & Length  
Diameter: 18ga, 17ga, 16ga, 15ga, 14ga, 13ga, 12ga, 3mm, 4mm.  
Length: 15cm, 23cm, 26cm.



### **MICRO INJECTION NEEDLE, STYLE 1**

Product Code: **2220 MIN1**

Available Diameter & Length  
Diameter: 18ga, 17ga, 16ga, 15ga, 14ga, 13ga, 12ga, 3mm, 4mm.  
Length: 15cm, 23cm, 26cm, 30cm, 32cm.



## Reinjection Micro Cannulas (cont.)



### **MICRO INJECTION NEEDLE "V" DISSECTOR**

Product Code: **IN"V" 2210 M**

Available Diameter & Length  
Diameter: 18ga, 17ga, 16ga.  
Length: 5cm, 7cm, 8cm, 9cm, 12cm.



### **BEVEL 45**

Product Code: **2195 45BEVEL**

Available Diameter & Length  
Diameter: 16ga, 15ga, 14ga.  
Length: 7cm, 9cm, 12cm, 15cm, 23cm.



### **BEVEL 30**

Product Code: **2195 30BEVEL**

Available Diameter & Length  
Diameter: 16ga, 15ga, 14ga.  
Length: 7cm, 9cm, 12cm, 15cm, 23cm.





## Infusion Handles



### INFUSION HANDLE WITH ON/OFF CONTROL

Model Number: 1040 INFU CSS

Product Description:

A flow on/off control infusion handle for use with roller pump devices.

Handle diameter: **15/16" (Stainless Steel control)**

Valve: **Stainless Steel**

Female Luer Lock: **Stainless Steel**

Male Luer Lock: **Stainless Steel**



### INFUSION HANDLE WITH ON/OFF CONTROL

Model Number:

1040 INFU C

Product Description:

A flow on/off control infusion handle for use with roller pump devices.

Handle diameter: **15/16" (control) 3/4" (handle)**

Valve: **Stainless Steel**

Female Luer Lock: **Stainless Steel**

Male Luer Lock: **Stainless Steel**



### INFUSION HANDLE WITH ON/OFF STOPCOCK CONTROL

Model Number:

1540 INFU SCC

Product Description:

Infusion Handle with Stopcock Control

Handle diameter: **3/4"**

Valve: **Brass with Electroless Nickel Plating**

Female Luer Lock: **Stainless Steel**

Male Luer Lock: **Stainless Steel**



## Infusion Handles (cont.)



### INFUSION HANDEL WITH ON/OFF STOPCOCK CONTROL

Model Number:  
1540 INFU SCC

Product Description:

Infusion Handle with Stopcock Control  
Handle diameter: **3/4"**

Valve: **Brass with Electroless Nickel Plating**  
Female Luer Lock: **Stainless Steel**  
Male Luer Lock: **Stainless Steel**



### INFUSION HANDLE WITH SWIVEL LUER NUT

Model Number:  
1535 INFU NC SN  
1535 INFU NC SN L (for 1" Dia.)

Product Description:

Standard Infusion Handle, No Control with Swivel Nut  
Handle diameter: **3/4"**

Female Luer Lock: **Stainless Steel**  
Male Swivel Luer Lock: **Stainless Steel**



### LUER LOCK ADJUSTABLE HANDLE

Model Number:  
1530 LLAH S (for small)  
1530 LLAH L (for large)

Product Description:

Luer Lock Adjustable Handle. Orientation between Luer Lock and Handle.

Handle diameter: **3/4" (for small) 1.0" (for large)**  
Female Luer Lock: **Stainless Steel**  
Male Luer Lock: **Stainless Steel**





## Infusion Handles (cont.)



### INFUSION HANDLE WITH TUBE CONNECTOR

Model Number:  
1030 INFU NC TC  
1030 INFU NC TC L (for 1" Dia.)

Product Description:

Infusion handle with tube connector for use with reusable infusion tubing.  
Handle diameter: **3/4"**  
Female Luer Lock: **Stainless Steel**  
Barb: **Stainless Steel**



### LUER LOCK ADJUSTABLE ASPIRATION HANDLE

Model Number:  
1525 LLAH

Product Description:

Luer Lock Adjustable Handle ideal for rotating the Luer Lock flat  
Handle diameter: **3/4"**  
Male Luer Lock: **Stainless Steel**



### ASPIRATION HANDLE

Model Number:  
1090 AH L (for large)  
1090 AH S (for small)

Product Description:

Standard Aspiration Handle  
Handle diameter: **3/4" (for small) 1.0" (for large)**  
Male Luer Lock: **Stainless Steel**



## Infusion Handles (cont.)



### INFUSION HANDLE WITH SWIVEL LUER NUT

Model Number:  
1535 INFU NC SN  
1535 INFU NC SN L (for 1" Dia.)

Product Description:

Standard Infusion Handle, No Control with Swivel Nut  
Handle diameter: **3/4"**  
Female Luer Lock: **Stainless Steel**  
Male Swivel Luer Lock: **Stainless Steel**





## Two piece Cannulas



### **QUICK DISCONNECT CANNULA SET**

Part Number:  
1160 QDH  
2010 MER315QDH

Product Description:

A quick Disconnect Handle is a quick and easy interchangeable cannula hub.

Overall length: **6.65"**

Body: **All Stainless Steel**

### **QUICK LOCK CANNULA SET**

Part Number:  
1350 QLH  
2020 III 315QLH

Product Description:

A quick Lock Handle is a quick and easy interchangeable Cannulas hub. Standard vented holes and swivel barb

Overall length: **6.65"**

Body: **Aluminum with type 2 blue anodized**

Lock : **Stainless Steel**



## Two piece Cannulas (cont.)



### QUICK LOCK CANNULA SET

Part Number:  
1350 QLH  
2020 III 315QLH

Product Description:

A quick Lock Handle is a quick and easy interchangeable Cannulas hub. Standard vented holes and swivel barb

Overall length: **6.65"**

Body: **Aluminum with type 2 blue anodized**

Lock : **Stainless Steel**



### TOOMEY ASPIRATION CANNULA SET

Part Number:  
1430 TAH  
2170 MS315T60SS

Product Description:

Toomey Aspiration Handle

Overall length: **7.1"**

Body: **Delrin (Autoclavable)**





## Two piece Cannulas (cont.)



### **LUER LOCK ADJUSTABLE ASPIRATION HANDLE**

Part Number:  
1525 LLAH

Product Description:

Luer Lock Adjustable Handle ideal for rotating the Luer Lock flat to the thumb rest

Handle diameter: **3/4"**

Overall length: **7.2"**

Body: **Aluminum with type 2 blue anodized**

Male Luer Lock: **Stainless Steel**



### **ASPIRATION HANDLE**

Part Number:  
1090 AH L (for large)  
1090 AH S (for small)

Product Description:

Standard Aspiration Handle

Handle diameter: **3/4" (for small)**

**1.0" (for large)**

Overall length: **6.85"**

Body: **Aluminum with type 2 blue anodized**

Male Luer Lock: **Stainless Steel**



# Injection Gun Set

## **INJECTION GUN SET 1ML, 3ML, 5ML, 10ML BD**

Part Number:

1215 IGS13510

Product Description:

Standard method of micro tissue injections.

All stainless steel

For 1ml, 3ml, 5ml, 10ml BD syringes

.15 ml per trigger on 1ml BD syringe

.32 ml per trigger on 3ml BD syringe

.62 ml per trigger on 5ml BD syringe

.88 ml per trigger on 10ml BD syringe



## **INJECTION GUN SET 3CC, 5CC, 10CC BD**

Part Number:

1220 IGS3510

Product Description:

Standard method of micro tissue injection. All stainless steel

For 3cc, 5cc, 10cc BD syringes

.32 ml per trigger on 3ml BD syringe

.62 ml per trigger on 5ml BD syringe

.88 ml per trigger on 10ml BD syringe





# Injection Gun Set (cont.)

IN

## INJECTION GUN SET 3CC

Part Number:  
1223 IGS3

Product Description:

Standard method of micro tissue injection. All stainless steel

For 3cc BD syringes

.32 ml per trigger on 3ml BD syringe



## INJECTION GUN SET 5CC

Part Number:

1225 IGS5

Product Description:

Standard method of micro tissue injection.

All stainless steel

For 5cc BD syringes



## Injection Gun Set (cont.)



### **INJECTION GUN SET 10CC**

Part Number:  
1227 IGS10

Product Description:

Standard method of micro tissue injection.  
All stainless steel  
For 10cc BD syringes  
.88 ml per trigger on 10ml BD syringe



### **INJECTION GUN SET 20CC**

Part Number:  
1235 IGS20

Product Description:

Standard method of micro tissue injection.  
All stainless steel  
For 20cc BD syringes  
1.5 ml per trigger on 20ml BD syringe





## Injection Gun Set (cont.)



### **INJECTION GUN SET 30CC**

Part Number:  
1238 IGS30

Product Description:

Standard method of micro tissue injections. All stainless steel

For 30cc BD syringes

1.7 ml per trigger on 30ml BD syringe



### **INJECTION GUN SET 60CC**

Part Number:  
1260 IGS60

Product Description:

Standard method of micro tissue injections.

All stainless steel

For 60cc Monoject syringes

1.9 ml per trigger on 60ml Monoject syringe



# Injection Gun Set (cont.)



## Additional Syringe Accessories

Part Number:	Product Description:
1265-PAR	Plunger Adaptor Removal
1220-02	Plunger adaptor for 3 ml
1220-03	Plunger adaptor for 5 ml
1220-04	Plunger adaptor for 10 ml
1235-02	Plunger adaptor for 20 ml
1237-02	Plunger adaptor for 30 ml
1240-02	Plunger adaptor for 35 ml
1260-02	Plunger adaptor for 60 ml

### Product Description:

This additional accessories are ideal for a surgeon who wants to have two or more syringes ready for tissue re-injection procedure.





## Toomey & Accessories



### **TOOMEY TO LUER LOCK SYRINGE**

Part Number:  
1320 T60 LLS SS

Product Description:  
Toomey 60cc Monoject to Luer Lock Syringe  
Stainless Steel and Stainless Steel hub



### **TOOMEY TO LUER LOCK SYRINGE**

Part Number:  
1320 T60 LLS AL

Product Description:  
Toomey 60cc Monoject to Luer Lock Syringe  
Female Luer Lock made of Stainless Steel and Aluminum  
hub



### **TOOMEY TO LUER LOCK NEEDLE**

Part Number:  
1340 T60 LLN SS

Product Description:  
Toomey 60cc Monoject to Luer Lock Needle  
Stainless Steel hub



## Toomey & Accessories (cont.)



### **TOOMEY TO LUER LOCK NEEDLE**

Part Number:  
1340 T60 LLN AL

Product Description:  
Toomey 60cc Monoject to Luer Lock Needle  
Male Luer Lock made of Stainless Steel and Aluminum  
hub



### **SYRINGE BARB ADAPTOR**

Part Number:  
1460 SBA60SS  
1465 SBA35SS  
1462 SBA10SS

Product Description:  
Syringe Barb Adapter  
Made of Stainless Steel



### **LUER LOCK TO LUER LOCK**

Part Number:  
1310 LL LL4

Product Description:  
Luer Lock syringe to Luer Lock syringe soft Tissues  
Transfer system  
Made of Stainless Steel





## Toomey & Accessories (cont.)



### IV SPIKE

Part Number:  
1180 IV SPIKE

Product Description:  
IV connector For use with Reusable tubing  
Body: Stainless Steel



### NEEDLE CONNECTOR

Part Number:  
1190 NC

Product Description:  
Needle connector For use with Reusable tubing.  
Overall length: **2.3"**  
Body: **Stainless Steel**  
Luer Lock: **Brass with Electroless Nickel Plating**



### SNAPPER LOCK

Part Number:  
1370 SL60 (for 60cc Monoject Toomey and BD syringe)  
1365 SL35 (for 35cc Catheter Syringe)  
1360 SL20 (for 20cc BD Syringe)  
1355 SL30 (for 30cc BD Syringe)  
1375 SL10 (for 10cc BD Syringe)  
1380 SL10 (for 10cc Monoject Oral Syringe)  
Product Description:  
Snapper Lock  
Made of Stainless Steel spring and Aluminum body

# Toomey & Accessories (cont.)



## TWIST LOCK

Part Number:  
 1280 TL60 (for 60cc Monoject Syringe)  
 1275 TL35 (for 35cc Monoject Syringe)  
 1295 TL20 (for 20cc BD Syringe)  
 1285 TL30 (for 30cc BD Syringe)  
 1290 TL10 (for 10cc BD Syringe)  
 1300 TL10 (for 10cc Monoject Oral Syringe)  
 Product Description:  
 Twist Lock  
 Made of Aluminum



## FEMALE LUER LOCK CAP

Part Number:  
 1305 FMLL SS  
 Product Description:  
 Female Luer Lock Cap  
 Made of Stainless Steel



## FEMALE LUER LOCK CAP

Part Number:  
 7320 FMLL  
 Product Description:  
 Female Luer Lock Cap  
 Made of Plated Brass





## Toomey & Accessories (cont.)



### **TOOMEY TO TOOMEY**

Part Number:  
1342 T60 T60

Product Description:  
Toomey 60cc to Toomey 60cc Monoject syringe  
Made of Stainless Steel



### **TOOMEY SYRINGE CAP**

Part Number:  
1002 TSCAP

Product Description:  
Toomey 60cc Syringe Cap, Made of Delrin Plastic  
(Autoclavable)

### **SYRINGE TIP CAPS**

Part Number:  
1000 SRCAP

Product Description:  
Syringe Tip Cap, 10/tray,  
Flexible. Integral Luer plug fits Luer tip and Luer Lock  
syringes. Caps positioned upright in tray wells  
Autoclavable. Sterile.





## Toomey & Accessories (cont.)



### **SYRINGE TIP CAPS**

Part Number:  
1000 SRCAP NS

Product Description:  
Cap Male Luer, with Threads, Red  
High Density Polyethylene  
Non Sterile



### **FEMALE LUER LOCK CAP**

Part Number:  
7320 FMLL

Product Description:  
Female Luer Lock Cap  
Made of Plated Brass





# Sterilization Tray

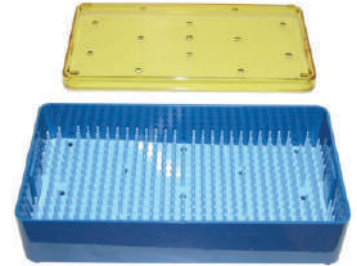

## PLASTIC STERILIZATION TRAY

Part No. 1020 PST

Plastic trays are sterilizable by all standard methods of sterilization. Trays are designed to encase instruments during processing. Safe for all standard sterilization methods. Autoclave/dry heat up to 360° F, ETO, and Cold Solutions.

Flexibility of layout. Finger tip mats.

Unique, "grid" system in all bases, trays, and lids makes it easy to install mats or inserts to protect your instruments.

4.0x7.5x1.5 Micro Tray Base Lid & Mat  
CLEANING BRUSH

Part No.	Description
1570 BR2	Cannula cleaning brush 2mm x 42cm
1570 BR3	Cannula cleaning brush 3mm x 48cm
1570 BR4	Cannula cleaning brush 4mm x 48cm
1570 BR5	Cannula cleaning brush 5mm x 48cm
1570 BR6	Cannula cleaning brush 6mm x 48cm
1575 CCS1630	Cannula cleaning stylet 16ga x 30cm
1575 CCS1830	Cannula cleaning stylet 18ga x 30cm



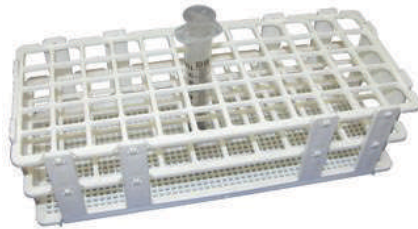

## Sterilization Tray (cont.)

### SYRINGE RACK

Part No.	# of Holes	Row	Colm	Holes Dia.	For Syringe
1660 SR60T	12	2	6	35mm	60cc TERUMO
1660 SR60	21	3	7	30mm	60cc BD, 35cc & 60cc Monoject
1660 SR30	24	3	8	25mm	30cc BD & 20cc Monoject
1660 SR20	40	4	10	20mm	20cc BD & 10cc Monoject
1660 SR10	60	5	12	16mm	10cc BD
1660 SR5	90	6	15	13mm	5cc, 3cc & 1cc BD

#### Product Description:

Plastic Syringe Racks are designed as syringe stands. Made of a special polypropylene, these racks are Autoclavable and will be able to stay submerged and maintain stability in water. They are easy to assemble and are stackable.





*Plastic Surgery*  
**Instruments Catalogue**



**INSTRUMEX**SURGICAL  
**I N S T R U M E N T S**



+92 337 311 2211



info@instrumexsurgical.com



www.instrumexsurgical.com



Circular Road, Sialkot-51310 Pakistan



/instrumex-surgical-8ab87132a

